



valve regulated
sealed lead acid type
rechargeable battery

sunbattery®

SB12-75(12V75AH)

Specification

Nominal Voltage	12V	
Nominal Capacity(10HR)	75.0AH	
Dimension	Length	260±3mm (10.24 inches)
	Width	168±2mm (6.61 inches)
	Container Height	210±3mm (8.19 inches)
	Total Height (with Terminal)	216±3mm (8.43 inches)
	Approx Weight	Approx 22.7 Kg (49.2lbs)
Terminal	T6	
Container Material	ABS	
Rated Capacity	78.0 AH/3.90A	(20hr , 1.80V/cell, 25°C/77°F)
	75.0 AH/7.50A	(10hr, 1.80V/cell, 25°C/77°F)
	64.5 AH/12.9A	(5hr, 1.75V/cell, 25°C/77°F)
	58.5 AH/19.5A	(3hr, 1.75V/cell, 25°C/77°F)
	45.8 AH/45.8A	(1hr 1.60V/cell 25°C/77°F)
Max. Discharge Current	900A (5s)	
Internal Resistance	Approx 6.6mΩ	
Operating Temp. Range	Discharge	-15~50°C (5~122°F)
	Charge	0~40°C (32~104°F)
	Storage	-15~40°C (5~104°F)
Nominal Operating Temp. Range	25±3°C (77±5°F)	
Cycle Use	Initial Charging Current less than 22.5A. Voltage	
	14.4V~15.0V at 25°C(77°F)Temp. Coefficient -30mV/°C	
Standby Use	No limit on Initial Charging Current Voltage	
	13.5V~13.8V at 25°C(77°F)Temp. Coefficient -20mV/°C	
Capacity affected by Temperature	40°C (104°F)	103%
	25°C (77°F)	100%
	0°C (32°F)	86%
Self Discharge	SUN SB series batteries may be stored for up to 6 months at 25°C(77°F) and then a freshening charge is required. For higher temperatures the time interval will be shorter.	
Life expectancy	8-12 years at 25°C with charge voltage 2.25V/cell.	



Applications

- ◆ All purpose
- ◆ Uninterruptable Power Supply (UPS)
- ◆ Electric Power System (EPS)
- ◆ Emergency backup power supply
- ◆ Emergency light
- ◆ Railway signal
- ◆ Aircraft signal
- ◆ Alarm and security system
- ◆ Electronic apparatus and equipment
- ◆ Communication power supply
- ◆ DC power supply
- ◆ Auto control system

Intertek ETL SEMKO		MH45680
ISO14001	ISO9001	

Comform to:
IEC60896-21&22 and/or IEC61427

Constant Current Discharge (Amperes) at 25 °C (77°F)

F.V/Time	5min	10min	15min	20min	30min	45min	1h	2h	3h	4h	5h	6h	8h	10h	20h
1.85V/cell	128.4	100.9	85.8	71.8	57.1	43.2	35.4	22.5	17.8	14.5	11.7	10.2	8.29	7.08	3.86
1.80V/cell	172.3	128.9	103.7	84.9	67.3	50.2	39.6	24.6	19.2	15.5	12.6	10.9	8.79	7.50	3.90
1.75V/cell	194.3	141.7	113.3	91.3	69.9	52.1	41.4	25.5	19.5	15.9	12.9	11.2	8.94	7.58	3.94
1.70V/cell	213.9	154.4	120.9	95.9	72.7	54.2	42.7	26.5	20.1	16.3	13.2	11.5	9.07	7.65	4.01
1.65V/cell	235.9	166.7	128.6	101.9	76.7	55.6	44.2	27.2	20.9	16.8	13.6	11.7	9.21	7.81	4.07
1.60V/cell	260.2	180.9	137.5	108.6	81.0	57.9	45.8	28.2	21.6	17.4	14.1	12.0	9.30	7.89	4.09

Constant Power Discharge (Watts/cell) at 25 °C (77°F)

F.V/Time	5min	10min	15min	20min	30min	45min	1h	2h	3h	4h	5h	6h	8h	10h	20h
1.85V/cell	234.7	186.4	160.1	135.3	108.7	83.0	68.2	43.7	34.7	28.4	23.0	20.1	16.4	14.0	7.65
1.80V/cell	311.7	235.4	190.9	157.6	126.3	95.8	76.0	47.4	37.1	30.2	24.6	21.4	17.3	14.8	7.71
1.75V/cell	343.9	254.5	205.9	167.9	130.1	98.4	79.1	49.0	37.7	30.8	25.1	22.0	17.6	14.9	7.78
1.70V/cell	368.2	271.1	216.8	175.1	134.6	102.0	81.4	50.8	38.7	31.5	25.7	22.4	17.8	15.1	7.92
1.65V/cell	400.3	289.9	228.8	184.7	140.9	103.6	83.5	52.0	40.1	32.5	26.3	22.8	18.0	15.4	8.02
1.60V/cell	431.3	307.6	240.6	194.6	147.7	107.4	86.0	53.4	41.2	33.4	27.1	23.2	18.2	15.5	8.05



Specifications subject to change without notice.

Dimensions

T6 Terminal

Unit: mm [inches]

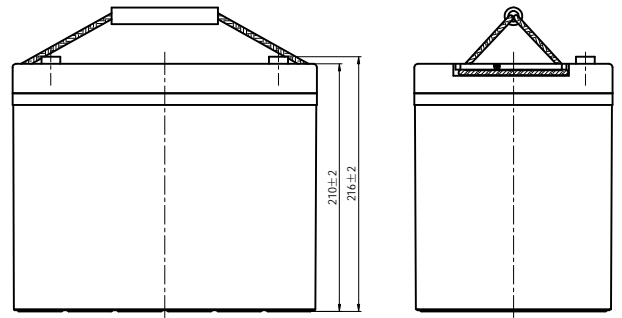
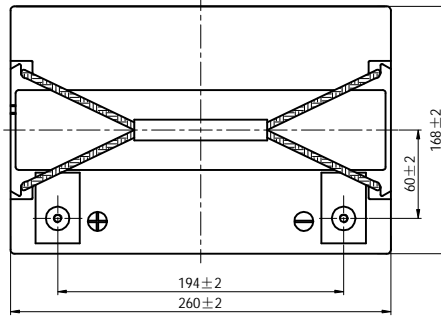
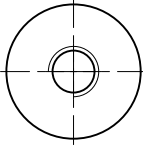
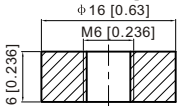

Discharge Characteristics

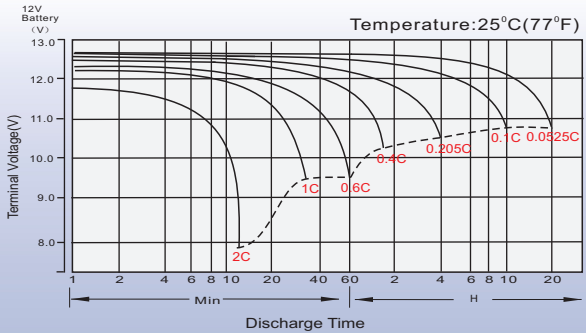

Charging Characteristics (cycle use)

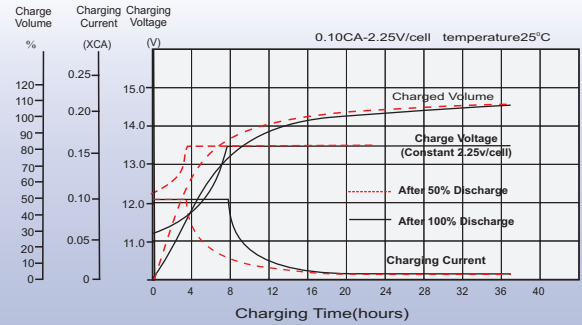

Temperature Effects in Relation to Battery Capacity

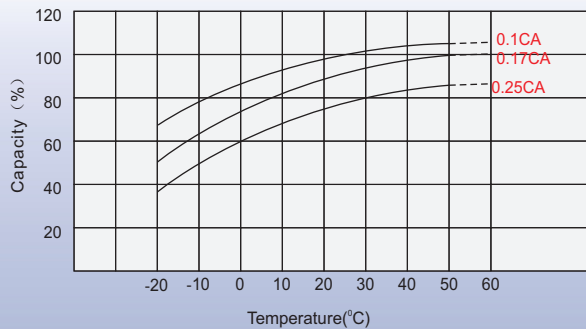

Effect of Temperature on Long Term Float Life

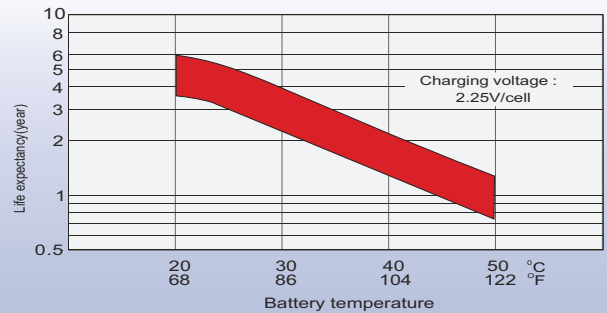

Cycle Life in Relation to Depth of Discharge

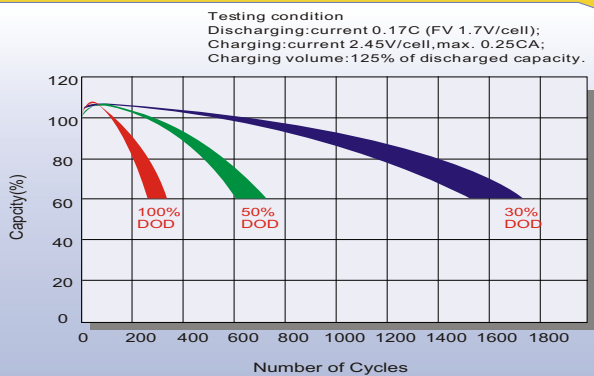

Self Discharge Characteristics

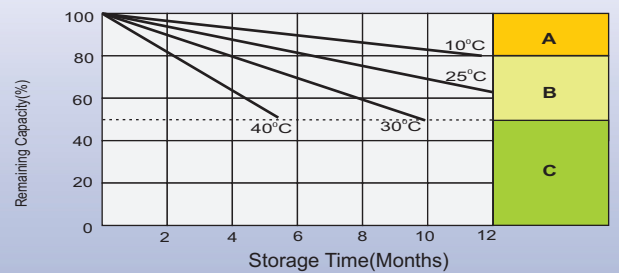

- A** No supplementary charge required
(Carry out supplementary charge before use if 100% capacity is required.)
- B** Supplementary charge required before use. Optional charging way as below:
1. Charged for above 3 days at limited current 0.25CA and constant voltage 2.25V/cell.
2. Charged for above 20 hours at limited current 0.25CA and constant voltage 2.45V/cell.
3. Charged for 8-10 hours at limited current 0.05CA.
- C** Supplementary charge may often fail to recover the capacity.
The battery should never be left standing till this is reached.