

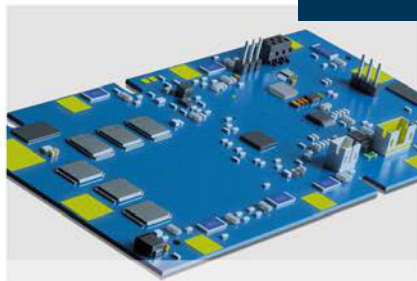

30 Years
of innovation & quality



Battery pack developments • Rechargeable batteries • Batteries

**Solutions for
mobile energy**

30 years, 2 generations, 1 goal: mobile energy.

Our success is based on our experience and the know-how of our highly qualified employees. Having built on this expertise for 30 years, the sustainable development of our family business, now in its second generation, with locations in Hamburg, Warsaw and Hong Kong, bears testament to this. As a highly competent partner for trade and industry, we offer you the most advanced battery and accumulator solutions.

Our sister company Wamtechnik is one of the TOP 5 battery pack assemblers in Europe. Our in-depth experience in project development enables us to devise unique system solutions together with you. From electronics to sophisticated design, we develop customised battery packs for a wide range of markets, industries and requirements. Throughout this process, we always advise you personally – with the aim of achieving the best possible result for your success.

We offer you the entire product range from a single source. In addition to the SUN Battery and SSB Battery brands we also stock products from major manufacturers including Exide, Panasonic, Samsung and Yuasa. This enables us to supply you with batteries and accumulators of any type, size or performance.

Our branch in Hong Kong guarantees constant quality control of all products in the local factories. Our site in Hamburg is also a DIN EN ISO 9001-certified company, which means that we are always at the cutting edge of technology. Equally, our checks and formation of the batteries adhere to the highest standards to consistently ensure the highest product quality.



Our products – not always visible but always close to you.



Security systems

To prepare for emergencies, we offer lead batteries of our premium brands for fire alarm systems, intruder alarm systems, smoke detection systems, alarm systems, electroacoustic systems and much more.



Warehouse logistics

In warehouse logistics, automated processes are gaining importance. That is why we also develop and produce system solutions for the energy supply of automated guided vehicles (AGVs).



UPS systems

UPS systems are mainly used in hospitals and data centres to ensure the continued supply of electrical equipment in the event of power grid faults. Here, battery blocks are interconnected to form entire battery systems.



Medical technology

From paperless patient management and operating theatre lighting to batteries for mobile defibrillators – the range of applications in medical technology is just as diverse as our customised battery solutions.



Emergency lighting

Emergency and safety lighting systems help people leave a building safely in the event of danger. To ensure the smooth operation of safety lighting systems in the event of a power failure, we offer you particularly reliable and high-quality batteries.



E-Mobility

In an ever more mobile world, the demands on our high-quality battery pack solutions for electric vehicles – for example in terms of longer ranges and shorter charging times – are also increasing.



Rehabilitation

In the physiotherapy/rehabilitation sector, high-cycle batteries are used to give patients more freedom of movement. For example, our lead-fleece (AGM) batteries are used in wheelchairs, stair lifts or scooters.



Energy storage

Producers of renewable energies need highly efficient storage solutions to store the energy they generate but don't immediately need and to make it available later. In addition, battery storage is required for intelligent grid stabilisation and charging infrastructure.

Your benefit: large product range from a single source.

As an experienced and competent partner, we offer you a wide range of very different products – from primary batteries and lead-acid batteries to innovative system solutions with complex battery management systems.

Our standard range of products is constantly available and is usually shipped within 24 hours. We offer versatile solutions beyond the normal package. Thanks to our trusted logistic partner, your goods are delivered to any destination safely and on time – if required, even straight to your technicians' vehicles.

Custom-built batteries



For more than 30 years, we have been working on the development of customised battery packs. At Battery-Kutter, we don't just focus on the specific selection of the right battery for your application, we also ensure modern monitoring and safety electronics are matched with the appropriate charging technology. We look forward to working with you to create your tailor-made solution.

AGM batteries



For many years, we have been successfully involved in supplying original equipment with our premium brand AGM batteries SUN Battery and SSB Battery for well-known manufacturers of fire and burglar alarm systems, UPS, emergency and safety lighting systems. We also offer gel batteries, pure lead batteries, traction batteries, starter batteries and industrial batteries by other manufacturers for a wide range of applications.

Systems solutions

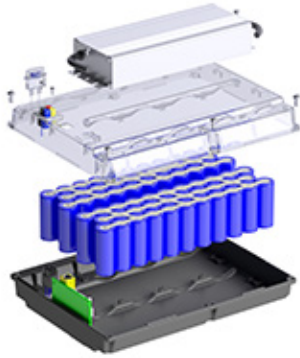

The complete development of your battery pack benefits from many years of our experience and knowledge in the field of charging technology, motors and controllers. We work closely with you to develop a comprehensive system, from electronics through to design, ready for series production. Needless to say, CAD drawings, prototyping and load profile tests are included in the development process as well as final (UN/UL/IEC) certification.

Battery management systems

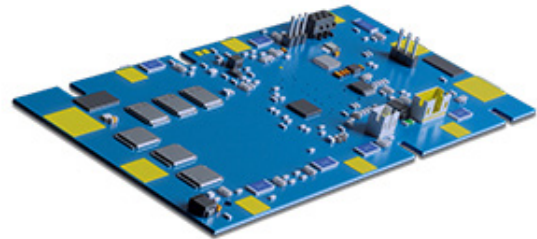

The further development of the classic protection circuit is reflected in our Battery management systems (BMS). Aside from the standard functions of the protection circuit, a BMS from Battery-Kutter provides much more data. For example, the state of charge, temperature, number of charging cycles and more can be read via an SM, I²C or CAN bus. We tailor the BMS around your individual application.

Batteries



Our consumer batteries, lithium batteries and button cells are non-rechargeable. They can be applied to smoke alarms, metres, remote control and back-up systems. We offer a large selection from different manufacturers – to suit diverse requirements and applications.

Charging technology



High-quality chargers, expertly matched to your application, are key to optimum capacity utilisation and to a long battery life. Finding the perfect charging technology to suit your battery is equally important to ensure the best performance. In cooperation with professional manufacturers, we develop customised chargers for you – on request and depending on the project.



Product	AGM battery
Version	Lead-fleece technology – grid plates, sealed
Condition	Filled and charged
Quality	Original equipment quality
Use	High cycle use
Shelf Life	Up to 12 months
Characteristics	Low self-discharge, absolutely maintenance-free
Application	Hazard alarm systems, fire alarm systems, alarm systems, burglar alarm systems, smoke extraction systems, heat extraction systems, video surveillance systems, voice alarm systems (VAS), electroacoustic public address systems (EPA), access control systems, etc.



Standard 6 V

Product	Volt (V)	Ah (C20)	Art. no.	Eurobat (years)	L x W x H in mm (H incl. terminal)	Weight (kg)	Terminal	PU (ctn.)	PU (pal.)	VdS no.
SB6-1.2	6	1.2	2031620	3–5	97 x 24 x 51.5 (57.5)	0.3	T1	20	–	–
SB6-12V0	6	12	2034163	3–5	151 x 51 x 94 (100)	2.0	T1	8	–	G112109

Standard 12 V

Product	Volt (V)	Ah (C20)	Art. no.	Eurobat (years)	L x W x H in mm (H incl. terminal)	Weight (kg)	Terminal	PU (ctn.)	PU (pal.)	VdS no.
MB12-0.8	12	0.8	2030817	3–5	96 x 25 x 62 (62)	0.3	AMP	20	–	–
SB12-1.2V0	12	1.2	2030719	6–9	97 x 43 x 52 (58)	0.6	T1	20	1800	G104066
SB12-2.3V0	12	2.3	2037507	6–9	178 x 35 x 60 (66)	1.0	T1	10	800	G117038
SB12-3.4V0	12	3.4	2032853	6–9	134 x 67 x 59.5 (65.5)	1.4	T1	10	600	G110026
SB12-7.2V0	12	7.2	2030721	6–9	151 x 65 x 93.5 (99)	2.3	T1	5	300	G112110
SB12-7.2LV0	12	7.2	2030722	6–9	151 x 65 x 93.5 (99)	2.3	T2	5	300	G112110
SB12-12V0	12	12	20311088	10–12	151 x 98 x 95 (101)	3.9	T1	4	240	G104069
SB12-12LV0	12	12	2030723	10–12	151 x 98 x 95 (101)	3.9	T2	4	240	G104069
SB12-18V0	12	18	2030724	10–12	181.5 x 77 x 167.5 (167.5)	5.7	F-M5	2	144	G112049
SB12-24V0	12	24	2030691	10–12	166 x 175 x 125 (125)	7.8	F-M5	2	120	G104071
SB12-26V0	12	26	2033380	10–12	166 x 175 x 125 (125)	8.0	F-M5	2	120	G112010
SB12-40V0	12	40	2037751	10–12	197 x 165 x 170 (170)	13.2	F-M6	1	80	G122031
SB12-45V0	12	45	2030855	10–12	197 x 165 x 170 (170)	14.5	F-M6	1	80	G112060
SB12-65SV0	12	65	2037619	10–12	260 x 168 x 173 (179)	19.2	F-M6	1	42	G116081
SB12-65V0	12	65	2030726	10–12	348 x 167 x 178 (178)	21.2	F-M6	1	36	G104073
SB12-100V0	12	100	2030792	10–12	330 x 173 x 212 (220)	32.0	F-M8	1	24	G116046



Please order by phone: +49 40 611 631-0, by email: bestellung@battery-kutter.de, by fax: +49 40 611 631-79 or visit our online shop: www.battery-kutter.de



Product High Cycle Series
Version Lead-fleece technology – grid plates, sealed
Condition Filled and charged
Quality Original equipment quality
Use High cycle use
Shelf life Up to 12 month
Characteristics Low self-discharge, absolutely maintenance-free
Application Rehabilitation technology (electric wheelchairs, stairlifts), mobile lifting platforms, wind energy systems, solar energy systems, caravans/motor-homes, sailing boats, electric boats, etc.



High Cycle Series

Product	Volt (V)	Ah (C20)	Art. no.	L x W x H in mm (H incl. terminal)	Weight (kg)	Terminal	PU (ctn.)	PU (pal.)
HC12-9 T2	12	9	2030304	151 x 65 x 94 (100)	2.8	T2	5	240
HC12-13 T2	12	13	2030305	151 x 98 x 95 (101)	4.4	T2	4	200
HC12-22 M5	12	22	2030306	181 x 77 x 167 (167)	5.9	F-M5	2	120
HC12-36 M6	12	36.2	2030307	195 x 130 x 155 (168)	11.0	F-M6	1	75
HC12-50 M6	12	50.2	2030308	197.5 x 165.5 x 170 (170)	14.6	F-M6	1	40
HC12-75 M6	12	75	2030309	258 x 166 x 210 (215)	24.0	F-M6	1	30
HC12-80 M6*	12	82	2030310	350 x 167 x 179 (179)	23.5	F-M6	1	24
HC12-100 M8*	12	108.6	2030311	330 x 171 x 215 (220)	30.0	F-M8	1	24

Terminals

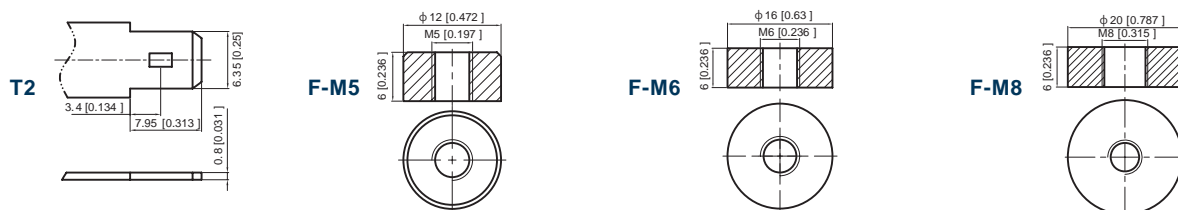

* On request

Please order by phone: +49 40 611 631-0, by email: bestellung@battery-kutter.de, by fax: +49 40 611 631-79 or visit our online shop: www.battery-kutter.de



Product	AGM battery
Version	Lead-fleece technology – grid plates, sealed
Condition	Filled and charged
Quality	Original equipment quality
Use	Short discharge times for high-current applications in the UPS sector as well as for applications with long autonomy time in the safety lighting
Shelf Life	Up to 12 months
Characteristics	Low self-discharge, absolutely maintenance-free
Application	Emergency power systems, UPS systems, CPS systems, emergency lighting, safety lighting, voice alarm systems (VAS), electroacoustic public address systems (EPA), etc.

SB/SBL (Life expectancy according to Eurobat 6–9 years or 10–12 years)

Product	Volt (V)	Ah (C10/C20*)	Art. no.	Eurobat (years)	L x W x H in mm (H incl. terminal)	Weight (kg)	Terminal	PU (ctn.)	PU (pal.)
SB5-12L	12	5,0*	100030	6-9	90 x 70 x 101 (107)	1.4	T2	10	500
SBL7.2-12L	12	7.2*	108026	10-12	151 x 65 x 94 (100)	2.2	T2	8	320
SBL9-12L	12	9*	108028	10-12	151 x 65 x 94 (100)	2.6	T2	10	300
SBL12-12L	12	12*	108039	10-12	151 x 98 x 95 (101)	3.7	T2	4	200
SBL18-12i	12	18*	108000	10-12	181 x 77 x 167 (167)	5.0	F-M5	2	120
SBL26-12i	12	26*	108001	10-12	166 x 176 x 125 (125)	7.4	F-M5	1	96
SBL28-12i	12	28*	108091	10-12	165 x 125 x 175 (175)	8.6	F-M5	1	90
SBL33-12i	12	33	108002	10-12	195 x 130 x 155 (168)	9.7	F-M6	1	75
SBL40-12i	12	40	108003	10-12	198 x 166 x 169 (169)	12.4	F-M6	1	60
SBL55-12i	12	55	158004	10-12	229 x 138 x 211 (213)	16.5	F-M6	1	42
SBL65-12i	12	65	108005	10-12	350 x 167 x 179 (179)	20.4	F-M6	1	36
SBL75-12i(sh)	12	75	108006	10-12	258 x 166 x 210 (215)	24.0	F-M6	1	32
SBL80-12i	12	80	108012	10-12	350 x 167 x 179 (179)	22.5	F-M6	1	36
SBL100-12i	12	100	108007	10-12	330 x 171 x 215 (222)	29.0	F-M8	1	24
SBL120-12i(sh)	12	110	108015	10-12	328 x 172 x 215 (222)	30.5	F-M8	1	24
SBL134R-12i	12	134	108027	10-12	341 x 173 x 283 (288)	40.0	F-M8	1	20
SBL150-12i	12	150	108016	10-12	482 x 170 x 240 (240)	44.8	F-M8	1	18
SBL200-12i	12	200	108017	10-12	522 x 238 x 218 (223)	59.1	F-M8	1	12
SBL260-12i**	12	260	140025	10-12	520 x 268 x 220 (225)	71.0	F-M8	1	12



** On request

Please order by phone: +49 40 611 631-0, by email: bestellung@battery-kutter.de, by fax: +49 40 611 631-79 or visit our online shop: www.battery-kutter.de

SSB Battery



Product	AGM battery
Version	Lead-fleece technology – grid plates, sealed
Condition	Filled and charged
Quality	Original equipment quality
Use	Short discharge times for high-current applications in the UPS sector as well as for applications with long autonomy time in the safety lighting
Shelf Life	Up to 12 months
Characteristics	Low self-discharge, absolutely maintenance-free
Application	Emergency power systems, UPS systems, CPS systems, emergency lighting, safety lighting, etc.

SBH (Life expectancy according to Eurobat 6–9 years)

Product	Volt (V)	Watt 10 min.	Art. no.	Eurobat (years)	L x W x H in mm (H incl. terminal)	Weight (kg)	Terminal	PU (ctn.)	PU (pal.)
SBH190-12	12	187.5	108029	6-9	90 x 70 x 101 (107)	1.6	T2	10	500
SBH200-12	12	170.5	108018	6-9	151 x 50 x 95 (101)	1.6	T1/T2	10	400
SBH300-12	12	306.9	108008	6-9	151 x 65 x 94 (100)	2.5	T2	8	288

Terminals

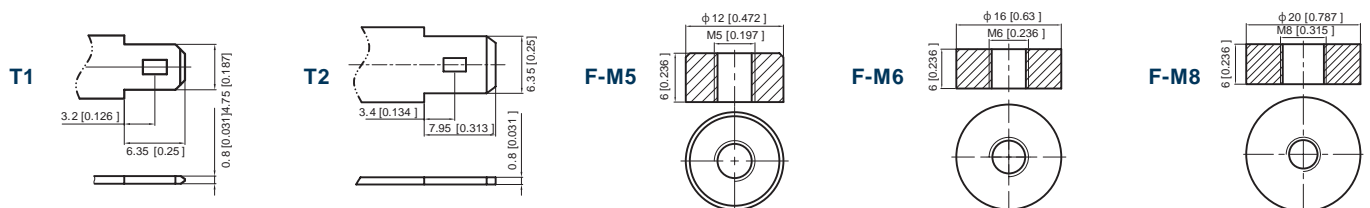

** On request

Please order by phone: +49 40 611 631-0, by email: bestellung@battery-kutter.de,
by fax: +49 40 611 631-79 or visit our online shop: www.battery-kutter.de



Product AGM battery
Version Lead-fleece technology – grid plates, sealed
Condition Filled and charged
Quality Original equipment quality
Use Short discharge times for high-current applications in the UPS sector as well as in the diesel start sector (emergency power supply systems)
Shelf life Up to 12 months
Characteristics Low self-discharge, absolutely maintenance-free, high temperature resistance (-20 °C ~ +60 °C), V0 housing (flame retardant according to UL94), long life expectancy (> 12 years according to Eurobat), fast recovery after deep discharge
Application Emergency power systems, UPS systems, CPS systems



SBL-HR Xtreme (Life expectancy according to Eurobat > 12 years)

Product	Volt (V)	Ah C10 / 1.8 V/Z	Watt 15 min, 1.6 V/Z	Art.-No.	Eurobat (years)	L x W x H in mm (H incl. terminal)	Weight (kg)	Terminal	PU (ctn.)	PU (pal.)
SBL120-12HR V0 Xtreme	12	26	118	SSB2037872	> 12	165 x 125 x 175 (175)	9.6	F-M5	1	84
SBL150-12HR V0 Xtreme	12	33	152	SSB2037873	> 12	195 x 130 x 155 (168)	11.5	F-M6	1	75
SBL200-12HR V0 Xtreme	12	55	204	SSB2037874	> 12	229 x 138 x 208 (213)	17.0	F-M6	1	32
SBL330-12HR V0 Xtreme	12	75	327	SSB2037875	> 12	258 x 166 x 210 (215)	24.5	F-M8	1	24
SBL410-12HR V0 Xtreme	12	90	412	SSB2037876	> 12	306 x 168 x 210 (215)	29.2	F-M8	1	24
SBL440-12HR V0 Xtreme	12	100	437	SSB2037877	> 12	328.5 x 172 x 212 (220)	32.3	F-M8	1	24
SBL500-12HR V0 Xtreme	12	134	503	SSB2037878	> 12	340 x 172 x 279 (286.5)	40.0	F-M8	1	20
SBL560-12HR V0 Xtreme	12	140	564	SSB2037879	> 12	341 x 173 x 279 (283)	41.0	F-M8	1	20
SBL730-12HR V0 Xtreme*	12	192	730	SSB2037900	> 12	530 x 209 x 215 (220)	57.0	F-M8	1	12
SBL830-12HR V0 Xtreme*	12	220	827	SSB2037901	> 12	522 x 238 x 218 (223)	67.5	F-M8	1	12

Terminals

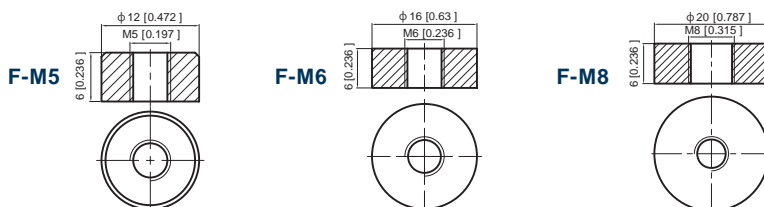

* On request



Please order by phone: +49 40 611 631-0, by email: bestellung@battery-kutter.de, by fax: +49 40 611 631-79 or visit our online shop: www.battery-kutter.de

SSB Grid Power Series



Product Version	AGM battery High temperature lead-acid batteries, sealed, absolutely maintenance-free, flame-retardant ABS-UL94-V0 casing
Condition Quality Use	Filled and charged Original equipment quality High ambient temperature, particularly high discharge over a short period of time
Shelf life	Up to 12 months
Characteristics	Absolutely maintenance-free, high-temperature lead-acid batteries; long life (EUROBAT classification: >12 years, Very Long Life); high savings potential in energy and maintenance costs
Application	Emergency power / UPS systems, emergency and safety lighting, switchgear, emergency power generator with diesel etc.
Design life	15 years at an ambient temperature of 35 °C
Warranty	5 years

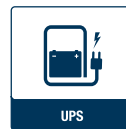
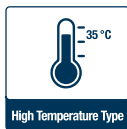

Grid Power Series

Product	Volt (V)	1.8 V C10 (Ah)	Art. no.	L x W x H in mm (H incl. terminal)	Weight (kg)	Terminal	PU (ctn.)	PU (pal.)
Grid Power 200-2HT M8V0	2	200	2037723	170 x 110 x 328 (348)	13.5	F-M8	2	72
Grid Power 300-2HT M8V0	2	300	2037724	170 x 150 x 328 (348)	18.8	F-M8	1	48
Grid Power 500-2HT M8V0	2	500	2037725	240 x 175 x 330 (350)	30.0	F-M8	1	32
Grid Power 800-2HT M8V0	2	800	2037727	410 x 175 x 330 (350)	50.4	F-M8	1	18
Grid Power 1000-2HT M8V0	2	1000	2037728	475 x 175 x 328 (350)	60.0	F-M8	1	16
Grid Power 1500-2HT M8V0	2	1500	2037729	403 x 354 x 339 (349)	97.8	F-M8	1	4
Grid Power 2000-2HT M8V0	2	2000	2037731	490 x 350 x 339 (349)	121.0	F-M8	1	4
Grid Power 3000-2HT M8V0	2	3000	2037732	709 x 350 x 337 (347)	183.0	F-M8	1	3

Terminals

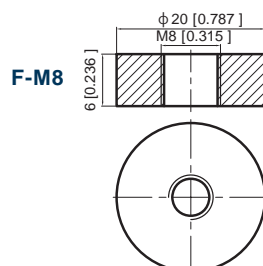

Please order by phone: +49 40 611 631-0, by email: bestellung@battery-kutter.de, by fax: +49 40 611 631-79 or visit our online shop: www.battery-kutter.de

SSB Battery Pure Lead Power



Article	AGM Battery (TPPL-Technology)
Version	Pure lead, sealed
Container Material	UL94-V0
Shelf life	Up to 24 months without recharging
Characteristics	TPPL technology („Thin Plate Pure Lead“): only this technology offers the real benefits of pure lead, fast charging: 90% within 90 minutes, very low self-discharge $\leq 0.5\%$ per month, absolutely maintenance-free
Application	UPS, CPS and CSS systems, emergency and safety lighting, telecommunications etc.
Life expectancy	15 years (top terminal (TT)) / 20 years (front terminal (FT))
Warranty	5 years*



**20
Years**

Design Life**

TPPL

Technology

5 Years

Warranty*

**-40 °C ~
+65 °C**

Temperature

**Up to
2 Years**

Shelf Life

Pure Lead Power Series

Product	Volt (V)	W (15 Min / 1.60 V)	Ah (C10, 1.8 V)	Art. no.	L x W x H in mm (H incl. Terminal)	Weight (kg)	Terminal FT / TT	VPE (Pal.)
PLP400-12 M8V0	12	400.7	85	SSB2037953	260 x 168 x 211	25.6	F-M8	28
PLP450-12 M8V0	12	447.0	95	SSB2037954	306 x 168 x 210	30.0	F-M8	24
PLP520-12 M8V0	12	524.8	108	SSB2037955	340.9 x 170 x 215.7	33.5	F-M8	24
PLP610-12 M8V0	12	612.4	135	SSB2037956	340.9 x 170 x 275.7	41.7	F-M8	24
PLP690-12 M8V0	12	685.7	146	SSB2037986	340.9 x 170 x 275.7	43.5	F-M8	24
PLP750-12 M8V0	12	745.1	162	SSB2037958	340.9 x 170 x 275.7	44.8	F-M8	24
PLP180-12FT M8V0	12	182.7	41	SSB2037902	298.7 x 97 x 184	12.5	M-M8/ F-M8	54
PLP280-12FT M8V0	12	283.2	68	SSB2037903	298,7 x 97 x 267	19.1	M-M8/ F-M8	36
PLP420-12FT M8V0	12	423.8	98	SSB2037904	405.4 x 108 x 287	28.7	M-M8/ F-M8	24
PLP450-12FT M8V0	12	450.0	109	SSB2037905	405.4 x 108 x 287	30.8	M-M8/ F-M8	24
PLP520-12FT M8V0	12	517.9	120	SSB2037906	559 x 125 x 227	36.5	M-M8/ F-M8	16
PLP680-12FT M8V0	12	676.3	162	SSB2037907	559 x 125 x 277	48.0	M-M8/ F-M8	16
PLP790-12FT M8V0	12	785.2	185	SSB2037908	559 x 125 x 320	54.2	M-M8/ F-M8	16
PLP840-12FT M8V0	12	839.9	207	SSB2037909	559 x 125 x 320	57.6	M-M8/ F-M8	16
PLP880-12FT M8V0	12	883.4	229	SSB2037910	559 x 125 x 328	60.5	M-M8/ F-M8	16

Front terminal (FT)

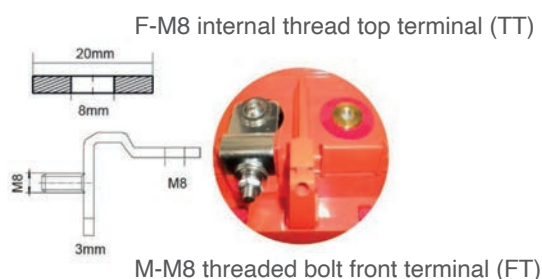

Top terminal (TT)

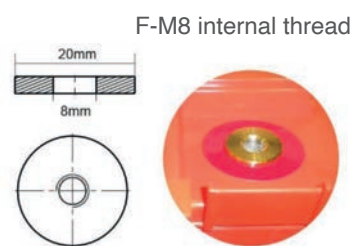

* In compliance with the warranty conditions
 ** Design Life: 15 years (top terminal (TT)) / 20 years (front terminal (FT))

**Please order by phone: +49 40 611 631-0, by email: bestellung@battery-kutter.de,
 by fax: +49 40 611 631-79 or visit our online shop: www.battery-kutter.de**

Fully insulated battery connectors and self-locking terminal screws



Article	Battery connectors and self-locking terminal screws
Version	Fully insulated (V0 design), short-circuit proof, VDE certified, precote® 85 thread lock
Quality	Original equipment quality
Properties	Highly flexible, easy and quick assembly; terminal screws: tightening torque: ≤ 15 Nm, they must not be retightened or reused after assembly
Application	Connection of battery blocks in emergency and safety lighting systems, emergency power and UPS systems, etc.

Block, row and level battery connectors, end arresters and self-locking terminal screws (V0-insulation)

Product	Art.no.	Hole spacing (mm)	Cross section (mm ²)	Connection
Block connector: fixed, fully overmolded, tinned	4001394	55	23 × 3	
Block connector: fixed, fully overmolded, tinned	4001395	75	23 × 3	
Row connector with flexible sealing lip	4001396	400	70	F-M8
Level connector with flexible sealing lip	4001397	1000	70	F-M8
Level connector with flexible sealing lip	4001563	3000	70	F-M8
Level connector with flexible sealing lip	4001564	5000	70	F-M8
End arrester with flexible sealing lip	4001398	3000	70	F-M8 with a molded head on one side
End arrester with flexible sealing lip	4001399	5000	70	F-M8 with a molded head on one side
End arrester with flexible sealing lip	4001400	10 000	70	F-M8 with a molded head on one side
Self-locking terminal screws	4001401			F-M8 × 18mm



Please order by phone: +49 40 611 631-0, by email: bestellung@battery-kutter.de,
by fax: +49 40 611 631-79 or visit our online shop: www.battery-kutter.de

Fully insulated battery connectors and self-locking terminal screws

Block connectors

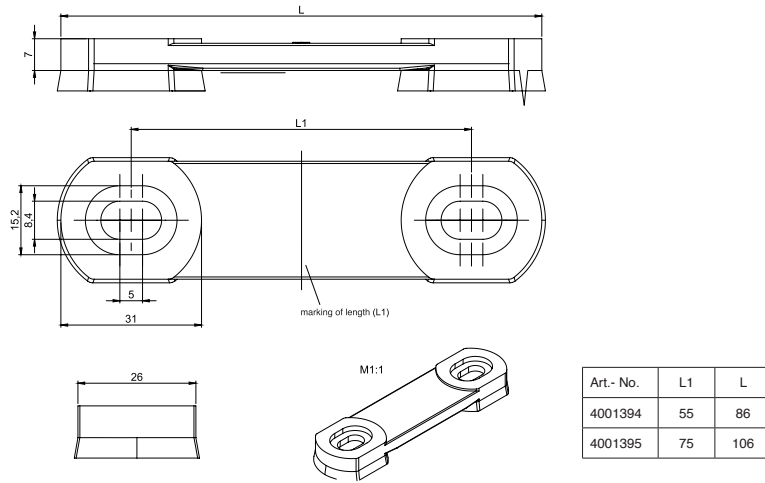

Row and level connectors / end arresters

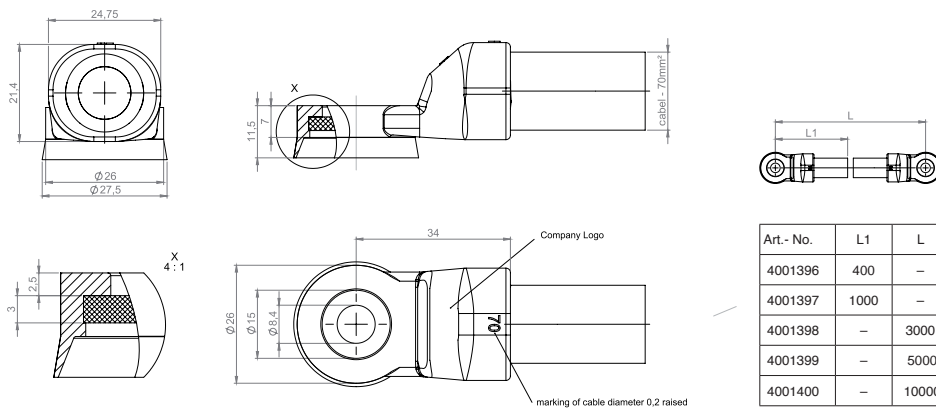

Self-locking terminal screws

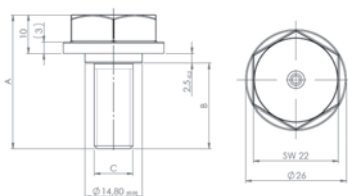

Please order by phone: +49 40 611 631-0, by email: bestellung@battery-kutter.de,
by fax: +49 40 611 631-79 or visit our online shop: www.battery-kutter.de

Battery connector



Article	Battery Connector
Version	NSGAFÖU version, short-circuit proof, VDE certified
Quality	Original equipment quality
Properties	Highly flexible
Application	Connection of battery blocks in emergency and safety lighting systems, emergency power and UPS systems, etc.

Block, series and tier connectors in 4mm² cross-section, NSGAFÖU

Product	Art. no.	Hole spacing (mm)	Cross section (mm ²)	Max. current (A)	Connection
Block connector 100-004-55 Fast-on connector 6.3mm	1020B20	100	4	55	6.3
Row connector 500-004-55 Fast-on connector 6.3mm	2023R23	500	4	55	6.3
Level connector 1000-004-55 Fast-on connector 6.3mm	3020E20	1000	4	55	6.3

Block, series and tier connectors in 16mm² cross-section, NSGAFÖU

Product	Art. no.	Hole spacing (mm)	Cross section (mm ²)	Max. current (A)	Connection
Block connector 50-016-132-M5	1002B02	50	16	132	M5
Block connector 50-016-132-M6	1003B03	50	16	132	M6
Block connector 80-016-132-M6	1006B06	80	16	132	M6
Block connector 120-016-132-M5	1022B22	120	16	132	M5
Block connector 120-016-132-M6	1024B24	120	16	132	M6
Row connector 400-016-132-M5	2022R22	400	16	132	M5
Row connector 400-016-132-M6	2028R28	400	16	132	M6
Level connector 680-016-132-M5	3002E02	680	16	132	M5
Level connector 680-016-132-M6	3004E04	680	16	132	M6
Level connector 1000-016-132-M5	3022E22	1000	16	132	M5
Level connector 1000-016-132-M6	3024E24	1000	16	132	M6

Block, series and tier connectors in 25mm² cross-section, NSGAFÖU

Product	Art. no.	Hole spacing (mm)	Cross section (mm ²)	Max. current (A)	Connection
Block connector 50-025-176-M6	1004B04	50	25	176	M6
Block connector 80-025-176-M6	1008B08	80	25	176	M6
Block connector 120-025-176-M6	1028B28	120	25	176	M6
Block connector 120-025-176-M8	1030B30	120	25	176	M8
Row connector 400-025-176-M6	2026R26	400	25	176	M6
Row connector 400-025-176-M8	2027R27	400	25	176	M8
Level connector 680-025-176-M6	3008E08	680	25	176	M6
Level connector 680-025-176-M8	3010E210	680	25	176	M8
Level connector 1000-025-176-M6	3027E27	1000	25	176	M6
Level connector 1000-025-176-M8	3028E28	1000	25	176	M8



Please order by phone: +49 40 611 631-0, by email: sales@battery-kutter.de,
by fax: +49 40 611 631-79 or visit our online shop: www.battery-kutter.de

Battery connector

Block, series and tier connectors in 35mm² cross-section, NSGAFÖU

Product	Art. no.	Hole spacing (mm)	Cross section (mm ²)	Max. current (A)	Connection
Block connector 120-035-218-M6	1049B49	120	35	218	M6
Block connector 120-035-218-M8	1048B48	120	35	218	M8
Row connector 400-035-218-M6	2031R31	400	35	218	M6
Row connector 400-035-218-M8	2029R29	400	35	218	M8
Level connector 1000-035-218-M6	3046E46	1000	35	218	M6
Level connector 1000-035-218-M8	3043E43	1000	35	218	M8

Block, series and tier connectors in 50mm² cross-section, NSGAFÖU

Product	Art. no.	Hole spacing (mm)	Cross section (mm ²)	Max. current (A)	Connection
Block connector 120-050-276-M6	1050B50	120	50	276	M6
Block connector 120-050-276-M8	1051B51	120	50	276	M8
Row connector 400-050-276-M6	2032R32	400	50	276	M6
Row connector 400-050-276-M8	2033R33	400	50	276	M8
Level connector 1000-050-276-M6	3047E47	1000	50	276	M6
Level connector 1000-050-276-M8	3048E48	1000	50	276	M8

Block, series and tier connectors in 70mm² cross-section, NSGAFÖU

Product	Art. no.	Hole spacing (mm)	Cross section (mm ²)	Max. current (A)	Connection
Block connector 120-070-347-M6	1052B52	120	70	347	M6
Block connector 120-070-347-M8	1053B53	120	70	347	M8
Row connector 400-070-347-M6	2034R34	400	70	347	M6
Row connector 400-070-347-M8	2030R30	400	70	347	M8
Level connector 1000-070-347-M6	3049E49	1000	70	347	M6
Level connector 1000-070-347-M8	3045E45	1000	70	347	M8

Block, series and tier connectors in 95mm² cross-section, NSGAFÖU

Product	Art. no.	Hole spacing (mm)	Cross section (mm ²)	Max. current (A)	Connection
Block connector 120-095-416-M8	1039B39	120	95	416	M8
Row connector 400-095-416-M8	2035R35	400	95	416	M8
Level connector 1000-095-416-M8	3038E38	1000	95	416	M8



Please order by phone: +49 40 611 631-0, by email: sales@battery-kutter.de,
by fax: +49 40 611 631-79 or visit our online shop: www.battery-kutter.de

Connector packages



Article
Version
Quality
Properties
Application

Battery Connector
NSGAFÖU version, short-circuit proof, VDE certified
Original equipment quality
Highly flexible
Connection of battery blocks in emergency and safety lighting systems, emergency power and UPS systems, etc.

Battery connectors as packages

Product	Art. no.	Description
Connector package 216V Fast-on 6.3mm	4000822	Suitable for 7Ah and 12Ah. Consisting of: 14 x Art. no.: 1020B20 - 100-004-Fast-on connector 6.3mm NSGAFÖU 2 x Art. no.: 2023R23 - 500-004-Fast-on connector 6.3mm NSGAFÖU 1 x Art. no.: 3020E20 - 1000-004-Fast-on connector 6.3mm NSGAFÖU
Connector package 216V 16qmm M5, BV 50	4000823	Suitable for 17Ah and 28Ah. Consisting of: 12 x Art. no.: 1002B02 - Block connector 50-016-132-M5 NSGAFÖU 4 x Art. no.: 2022R22 - Row connector 400-016-132-M5 NSGAFÖU 2 x Art. no.: 3022E22 - Level connector 1000-016-132-M5 NSGAFÖU Line-up: 2E-3R / 3E-2R
Connector package 216V 16qmm M5, BV 120	4000816	Suitable for 17Ah and 28Ah. Consisting of: 12 x Art. no.: 1022B02 - SBNF 120-016-132-M5 NSGAFÖU 4 x Art. no.: 2022R22 - SBNF 400-016-132-M5 NSGAFÖU 2 x Art. no.: 3022E22 - SBNF 1000-016-132-M5 NSGAFÖU Line-up: 2E-3R / 3E-2R
Connector package 216V 16qmm M6, BV 50	4000824	Suitable for 33Ah and 55Ah. Consisting of: 12 x Art. no.: 1003B03 - Block connector 50-016-132-M6 NSGAFÖU 4 x Art. no.: 2028R28 - Row connector 400-016-132-M6 NSGAFÖU 2 x Art. no.: 3024E24 - Level connector 1000-016-132-M6 NSGAFÖU Line-up: 2E - 3R / 3E-2R
Connector package 216V 16qmm M6, BV 80	4000825	Suitable for 60Ah and 75Ah. Consisting of: 12 x Art. no.: 1006B06 - Block connector 80-016-132-M6 NSGAFÖU 4 x Art. no.: 2028R28 - Row connector 400-016-132-M6 NSGAFÖU 2 x Art. no.: 3024E24 - Level connector 1000-016-132-M6 NSGAFÖU Line-up: 2E - 3R / 3E-2R
Connector package 216V 16qmm M6, BV 120	4000826	Suitable for 65Ah and 80Ah. Consisting of: 12 x Art. no.: 1024B24 - Block connector 120-016-132-M6 NSGAFÖU 4 x Art. no.: 2028R28 - Row connector 400-016-132-M6 NSGAFÖU 2 x Art. no.: 3024E24 - Level connector 1000-016-132-M6 NSGAFÖU Line-up: 2E - 3R / 3E-2R
Connector package 216V 25qmm M6, BV 50	4000828	Suitable for SBL HR 41Ah to 66Ah / SBL 33Ah to 55Ah. Consisting of: 12 x Art. no.: 1004B04 - Block connector 50-025-176-M6 NSGAFÖU 4 x Art. no.: 2026R26 - Row connector 400-025-176-M6 NSGAFÖU 2 x Art. no.: 3027E27 - Level connector 1000-025-176-M6 NSGAFÖU Line-up: 2E-3R / 3E-2R
Connector package 216V 25qmm M6, BV 80	4000829	Suitable for SBL HR 85Ah / SBL 60Ah + 75Ah. Consisting of: 12 x Art. no.: 1008B08 - Block connector 80-025-176-M6 NSGAFÖU 4 x Art. no.: 2026R26 - Row connector 400-025-176-M6 NSGAFÖU 2 x Art. no.: 3027E27 - Level connector 1000-025-176-M6 NSGAFÖU Line-up: 2E - 3R / 3E - 2R
Connector package 216V 25qmm M8, BV 120	4000827	Suitable from 100Ah. Consisting of: 16 x Art. no.: 1030B30 - Block connector 120-025-176-M8 NSGAFÖU 4 x Art. no.: 2027R27 - Row connector 400-025-176-M8 NSGAFÖU 2 x Art. no.: 3028E28 - Level connector 1000-025-176-M8 NSGAFÖU Line-up: 1E - 2R / 2E - 3R / 3E - 2R
Connector package 216V 35qmm M8, BV 120	4000830	Suitable from 100Ah. Consisting of: 16 x Art. no.: 1048B48 - Block connector 120-035-218-M8 NSGAFÖU 4 x Art. no.: 2029R29 - Row connector 400-035-218-M8 NSGAFÖU 1 x Art. no.: 3043E43 - Level connector 1000-035-218-M8 NSGAFÖU Line-up: 1E - 2R / 2E - 3R



Please order by phone: +49 40 611 631-0, by email: sales@battery-kutter.de,
by fax: +49 40 611 631-79 or visit our online shop: www.battery-kutter.de

Battery-Kutter is your competent partner with more than 30 years of experience in the development of customised battery packs. We develop Li-ion-, LiFePO₄- and NiMH-based solutions for a range of markets and applications. Our EN ISO 9001-certified sister company Wamtechnik in Warsaw employs a 60-member team of engineers and is one of the top 5 battery pack assemblers in Europe.

Custom-built batteries



At Battery-Kutter, we prioritise not only the careful selection of cells suitable for your application but also the adaptation of modern surveillance and security electronics with the appropriate charging technology. We are looking forward to finding a custom-made solution together with you.

System solutions



Extensive experience in charging technology, motors and controllers enables us to use our know-how throughout the entire development of your battery pack. We are capable of optimising a complete system with you, in terms of electromechanics or design, and to bring it to mass production stage. Needless to say, CAD drawings, prototyping and load profile tests are included in the development process.

Battery management systems

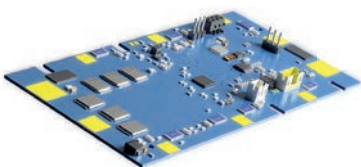

In our BMS, you'll find the evolution of the classic protection circuit. In addition to the standard functions of protection circuitry, a BMS provides more relevant data, such as the current charge state, temperature, number of charge cycles and other information for further processing. This data can be read via a SM, I²C or CAN bus. We will set up the BMS specifically for your application. The BMS is not offered separately but adapted to your system in combination with the battery pack development.



We look forward to working with you to create your custom-made solution.

Please call us on +49 40 611 631-0 or email us at: info@battery-kutter.de – we will be delighted to assist you.

Battery-Kutter offers you a swift transition of innovative ideas to market-ready solutions. With more than 2000 tested and ready-to-use modules, we have the capability to build many projects on existing circuit boards. Extensive testing, validation and in-house UN certifications enable us to achieve optimal time-to-market.

Standardised energy solutions



In addition to battery pack assembly for individual customer requirements, Battery-Kutter also offers various standard lithium-ion battery packs ranging from 3.2 V bis 51.2 V. All standard battery packs adhere to the necessary UN Transportation Testing (test certificate according to UN 38.3) and are also optionally available with a IEC 62133 / UL 2054 certificate.

Charging technology



Professional battery chargers with the right specifications for your application are essential for optimal use of the capacity and long battery life. Our product range includes high-quality manufacturers, who will, depending on the project, also develop custom-made types for you.



We look forward to working with you to create your custom-made solution.

Please call us on +49 40 611 631-0 or email us at: info@battery-kutter.de – we will be delighted to assist you.

Battery-Kutter Battery Packs

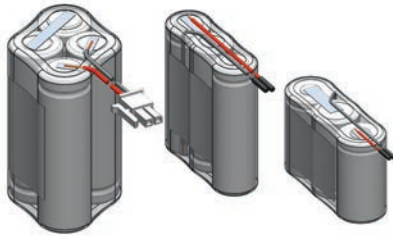

Product	Battery-Kutter Battery Packs
Version	Nickel-cadmium (NiCd) / Nickel-metal hydride (NiMH) batteries
Quality	Original equipment quality
Shelf life	Up to 12 months
Characteristics	Low self-discharge, very good performance
Application	Emergency and escape route lighting

NiCd / NiMH Battery Packs

Picture	Product	Art. no.	Volt (V)	mAH	L x W x H (mm) (H without connection)	Order (pcs.)
	Battery pack 2.4 V 1500 mAh NiCd L2x1 stick 2 x Sub-C high-temperature cells with 20 cm cable	2500052	2.4	1500	23 x 86	
	Battery pack 2.4 V 1800 mAh NiCd L2x1 stick 2 x Sub-C high-temperature cells with 20 cm cable	24012873	2.4	1800	23 x 85	
	Battery pack 2.4 V 2500 mAh NiCd L2x1 stick 2 x C high-temperature cells with 20 cm cable	2500006	2.4	2500	26.2 x 100	
	Battery pack 2.4 V 4000 mAh NiCd F2x1 row 2 x D high-temperature cells with 20 cm cable	2500222	2.4	4000	65.5 x 33 x 62.5	
	Battery pack 2.4 V 4000 mAh NiCd L2x1 stick 2 x D high-temperature cells with 20 cm cable	2500120	2.4	4000	33 x 119	
	Battery pack 2.4 V 4000 mAh NiCd L2x1 stick 2 x D high-temperature cells with Fast-On +6.3/-4.8 mm	2500209	2.4	4000	32.5 x 118	
	Battery pack 3.6 V 1500 mAh NiCd F3x1 row 3 x Sub-C high-temperature cells with 20 cm cable	2500223	3.6	1500	67.5 x 22.5 x 45	
	Battery pack 3.6 V 1500 mAh NiCd L3x1 stick 3 x Sub-C high-temperature cells with 20 cm cable	2500224	3.6	1500	22.5 x 127	
	Battery pack 3.6 V 1500 mAh NiCd L3x1 stick 3 x Sub-C high-temperature cells with Fast-On +6.3/-4.8 mm	2500210	3.6	1500	22.5 x 126	
	Battery pack 3.6 V 1500 mAh NiMH F3x1 row 3 x AA cells with 20 cm cable	2500211	3.6	1500	43 x 15 x 51	
	Battery pack 3.6 V 1500 mAh NiMH L3x1 stick 3 x AA cells with Fast-On +6.3/-4.8 mm	2500212	3.6	1500	15.2 x 152	
	Battery pack 3.6 V 1800 mAh NiCd F3x1 row 3 x Sub-C high-temperature cells with 20 cm cable	2500225	3.6	1800	67.5 x 22.5 x 45	
	Battery pack 3.6 V 1800 mAh NiCd L3x1 stick 3 x Sub-C high-temperature cells with 20 cm cable	2500213	3.6	1800	23 x 127.5	



Please order by phone: +49 40 611 631-0, by email: sales@battery-kutter.de,
by fax: +49 40 611 631-79 or visit our online shop: www.battery-kutter.de

Battery-Kutter Battery Packs

Picture	Product	Art. no.	Volt (V)	mAH	L x W x H (mm) (H without connection)	Order (pcs.)
	Battery pack 3.6 V 2500 mAh NiCd F3x1 row 3 x C high-temperature cells with 20 cm cable	2500226	3.6	2500	77.5 x 26 x 51.5	
	Battery pack 3.6 V 2500 mAh NiCd L3x1 stick 3 x C high-temperature cells with 20 cm cable	2500227	3.6	2500	26 x 147	
	Battery pack 3.6 V 4000 mAh NiCd F3x1 row 3 x D high-temperature cells with 20 cm cable	2500214	3.6	4000	98 x 33 x 63	
	Battery pack 3.6 V 4000 mAh NiCd F3x1 stick 3 x D high-temperature cells with 20 cm cable	2500215	3.6	4000	32.5 x 177	
	Battery pack 3.6 V 4000 mAh NiCd L3x1 stick 3 x D high-temperature cells with Fast-On +6.3/-4.8 mm	2500216	3.6	4000	32.5 x 177	
	Battery pack 3.6 V 4000 mAh NiCd L3x1 stick 3 x D high-temperature cells with 20 cm cable	2500228	3.6	4000	33 x 178	
	Battery pack 4.8 V 1200 mAh NiMH F2x2 double row 4 x AA high-temperature cells with 20 cm cable and Molex 43025-0200	2500229	4.8	1200	29 x 29 x 51	
	Battery pack 4.8 V 1200 mAh NiMH F2x2 double row/half 4 x AA high-temperature cells with 20 cm cable and and Molex 43025-0200	2500230	4.8	1200	36 x 26.5 x 51	
	Battery pack 4.8 V 1500 mAh NiCd L4x1 stick 4 x Sub-C high-temperature cells with 20 cm cable	2501254	4.8	1500	23 x 172	
	Battery pack 4.8 V 1800 mAh NiCd F4x1 row 4 x Sub-C high-temperature cells with 20 cm cable	2500217	4.8	1800	90 x 23 x 45	
	Battery pack 4.8 V 1800 mAh NiCd L4x1 stick 4 x Sub-C high-temperature cells with 20 cm cable	2500218	4.8	1800	23 x 170	
	Battery pack 4.8 V 2500 mAh NiCd L4x1 stick 4 x C high-temperature cells with 20 cm cable	2501226	4.8	2500	26.2 x 200	
	Battery pack 4.8 V 4000 mAh NiCd F4x1 row 4 x D high-temperature cells with 20 cm cable	2500016	4.8	4000	132 x 33 x 61	
	Battery pack 4.8 V 4000 mAh NiCd F4x1 row 4 x D high-temperature cells with Fast-On +6.3/-4.8 mm	2500219	4.8	4000	131 x 33 x 60	
	Battery pack 4.8 V 4000 mAh NiCd L4x1 stick 4 x D high-temperature cells with 20 cm cable	2500231	4.8	4000	33 x 236	





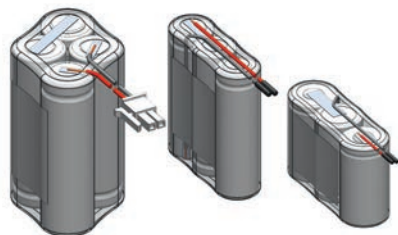

Please order by phone: +49 40 611 631-0, by email: sales@battery-kutter.de,
by fax: +49 40 611 631-79 or visit our online shop: www.battery-kutter.de

Battery-Kutter Battery Packs



Product	Battery-Kutter Battery Packs
Version	Nickel-cadmium (NiCd) / Nickel-metal hydride (NiMH) batteries
Quality	Original equipment quality
Shelf life	Up to 12 months
Characteristics	Low self-discharge, very good performance
Application	Emergency and escape route lighting

Picture	Product	Art. no.	Volt (V)	mAH	L x W x H (mm) (H without connection)	Order (pcs.)
	Battery pack 4.8 V 4000 mAh NiCd L4x1 stick 4 x D high-temperature cells with Fast-On +6.3/-4.8mm	2500220	4.8	4000	32.5 x 236	
	Battery pack 4.8 V 4500 mAh NiCd L4x1 stick 4 x D high-temperature cells with 20 cm cable	2500221	4.8	4500	33 x 236	
	Battery pack 6 V 4000 mAh NiCd L5x1 stick 5 x D high-temperature cells with 20 cm cable	2500005	6	4000	33 x 305	
	Battery pack 12 V 800 mAh NiCd F5x2 double row 10 x AA high-temperature cells with 20 cm cable	2500206	12	800	71 x 29 x 51	
	Battery pack 12 V 800 mAh NiCd F5x2 double row 10 x AA high-temperature cells with soldering lug	2500207	12	800	71 x 29 x 50	
	Battery pack 12 V 1800 mAh NiCd F5x2 double row 10 x Sub-C high-temperature cells with solder tag	2500208	12	1800	112.5 x 45.5 x 43	



Please order by phone: +49 40 611 631-0, by email: sales@battery-kutter.de,
by fax: +49 40 611 631-79 or visit our online shop: www.battery-kutter.de



Product	GEL batteries
Version	GEL technology – grid plates, sealed
Condition	Filled and charged
Quality	Original equipment quality
Use	High cyclic use
Shelf life	Up to 12 months
Characteristics	Low self-discharge, absolutely maintenance-free
Application	Hazard and smoke detection systems, emergency lighting, electric wheel-chairs, mobile lifting platforms, cleaning equipment, solar applications, construction site lighting, emergency power and UPS systems, etc.

Sonnenschein A500

Product	Volt (V)	Ah (C20)	Art. no.	Eurobat (years)	L x W x H (mm)	Weight (kg)	Connector
A502/10 S*	2	10	91163845	10–12	52.9 x 50.5 x 98.4	0.7	4.8 mm
A504/3.5 S*	4	3.5	203063	10–12	90.5 x 34.5 x 64.4	0.5	4.8 mm
A506/1.2 S*	6	1.2	2031054	10–12	97.3 x 25.5 x 55.6	0.3	4.8 mm
A506/3.5 S*	6	3.5	2030071	10–12	135 x 34.8 x 64.4	0.7	4.8 mm
A506/6.5 S*	6	6.5	203095	10–12	152 x 34.5 x 98.4	1.3	4.8 mm
A506/10 S*	6	10	91163265	10–12	152 x 50.5 x 98.4	2.1	4.8 mm
A508/3.5 S*	8	3.5	200176	10–12	179 x 34.1 x 64.4	1.0	4.8 mm
A512/1.2 S*	12	1.2	203026	10–12	97.5 x 49.5 x 54.9	0.6	4.8 mm
A512/2 S*	12	2	512200	10–12	179 x 34.1 x 64.4	1.0	4.8 mm
A512/3.5 S*	12	3.5	2030832	10–12	135 x 66.8 x 64.4	1.5	4.8 mm
A512/6.5 S*	12	6.5	203840	10–12	152 x 65.5 x 98.4	2.6	4.8 mm
A512/10 S*	12	10	200178	10–12	152 x 98 x 98.4	4.0	4.8 mm
A512/16 G5*	12	16	2030442	10–12	181 x 76 x 167	6.0	M5
A512/25 G5	12	25	203094	10–12	167 x 176 x 126	9.6	M5
A512/30 G6	12	30	2030811	10–12	197 x 132 x 180	11.1	M6
A512/40 A	12	40	2030441	10–12	210 x 175 x 175	14.2	A-Pol
A512/40 G6	12	40	203125	10–12	210 x 175 x 175	14.2	M6
A512/55 A	12	55	200177	10–12	261 x 135 x 230	18.1	A-Pol
A512/60 A	12	60	2030443	10–12	278 x 175 x 190	20.3	A-Pol
A512/60 G6	12	60	2030778	10–12	278 x 175 x 190	20.3	M6
A512/65 A	12	65	2031016	10–12	353 x 175 x 190	23.0	A-Pol
A512/65 G6	12	65	2031440	10–12	353 x 175 x 190	23.0	M6
A512/85 A	12	85	203077	10–12	330 x 171 x 236	29.2	A-Pol
A512/115 A	12	115	203061	10–12	286 x 269 x 230	37.5	A-Pol
A512/120 A	12	120	91262125	10–12	513 x 189 x 223	39.0	A-Pol
A512/140 A	12	140	2031170	10–12	513 x 223 x 223	47.0	A-Pol
A512/200 A	12	200	2030863	10–12	518 x 274 x 238	63.5	A-Pol

* Discontinued item from the manufacturer >>> Please send us your inquiry.



Please order by phone: +49 40 611 631-0, by email: bestellung@battery-kutter.de,
by fax: +49 40 611 631-79 or visit our online shop: www.battery-kutter.de



Product	GEL batteries
Version	GEL technology – grid plates, sealed
Condition	Filled and charged
Quality	Original equipment quality
Use	High cyclic use
Shelf life	Up to 12 months
Characteristics	Low self-discharge, absolutely maintenance-free
Application	Hazard and smoke detection systems, emergency lighting, electric wheel-chairs, mobile lifting platforms, cleaning equipment, solar applications, construction site lighting, emergency power and UPS systems, etc.

Sonnenschein GF-Y

Product	Volt (V)	Ah (C5)	Art. no.	Eurobat (years)	L x W x H (mm)	Weight (kg)	Connector
GF12014YF*	12	14	2030446		181 x 76 x 167	6.0	G-M5
GF12022YF	12	22.2	2030407		167 x 176 x 126	8.5	F-M5
GF12025YG	12	25	203011		197 x 132 x 180	11.1	G-M5
GF12033Y1	12	32.5	91189255		210 x 175 x 175	14.6	A-Pol
GF12033YG1	12	32.5	2030447		210 x 175 x 175	14.6	G-M6
GF12033YG2	12	32.5	20310233		210 x 175 x 175	14.6	G-M6
GF12040Y	12	40	2033960		242 x 175 x 190	17.5	A-Pol
GF12044Y	12	44	2031847		261 x 135 x 230	18.0	A-Pol
GF12051Y1	12	51	2030501		278 x 175 x 190	20.8	A-Pol
GF12051YG1	12	51	91194975		278 x 175 x 190	20.8	G-M6
GF12051Y2	12	51	20310234		278 x 175 x 190	20.8	A-Pol
GF12052YO	12	52.7	2034437		261 x 170 x 178	19.8	F-M6
GF12063YO4	12	63	20310569		261 x 171 x 210	22.2	F-M6
GF12065Y	12	65	93118435		353 x 175 x 190	26.8	A-Pol
GF12072Y	12	72	2030450		330 x 171 x 236	28.2	A-Pol
GF12094Y	12	93.5	2032818		286 x 269 x 230	38.5	A-Pol

* Discontinued item from the manufacturer >>> Please send us your inquiry.



Please order by phone: +49 40 611 631-0, by email: bestellung@battery-kutter.de,
by fax: +49 40 611 631-79 or visit our online shop: www.battery-kutter.de



Product	GEL batteries
Version	GEL technology – grid plates, sealed
Condition	Filled and charged
Quality	Original equipment quality
Use	High cyclic use
Shelf life	Up to 12 months
Characteristics	Low self-discharge, absolutely maintenance-free
Application	Hazard and smoke detection systems, emergency lighting, electric wheel-chairs, mobile lifting platforms, cleaning equipment, solar applications, construction site lighting, emergency power and UPS systems, etc.

Sonnenschein Solar

Product	Volt (V)	Ah (C100)	Art. no.	Eurobat (years)	L x W x H (mm)	Weight (kg)	Connector
S12/6.6 S*	12	6.6	93107015		152 x 65.5 x 98.4	2.6	S-4.8
S12/17 G5*	12	17	2030756		181 x 76 x 167	6.1	G-M5
S12/27 G5	12	27	2031143		167 x 176 x 126	9.6	G-M5
S12/32 G6	12	32	2030970		197 x 132 x 179	11.1	G-M6
S12/41 A	12	41	91211755		210 x 175 x 175	14.2	A-Pol
S12/60 A	12	60	2030487		261 x 136 x 230	18.1	A-Pol
S12/85 A	12	85	91234225		353 x 175 x 190	25.5	A-Pol
S12/90 A	12	90	2031898		330 x 171 x 236	28.2	A-Pol
S12/130 A	12	130	2030805		286 x 269 x 230	36.7	A-Pol
S12/230 A	12	230	2031110		518 x 274 x 238	63.5	A-Pol

Sonnenschein Solar Block

Product	Volt (V)	Ah (C100)	Art. no.	Eurobat (years)	L x W x H (mm)	Weight (kg)	Connector
SB6/200 A	6	200	93106825		246 x 192 x 275	29.0	A-Pol
SB6/330 A	6	330	20310238		312 x 182 x 359	47.0	A-Pol
SB12/60 A	12	60	20310237		278 x 175 x 190	18.0	A-Pol
SB12/75 A	12	75	93107045		330 x 171 x 236	28.8	A-Pol
SB12/100 A	12	100	91226025		513 x 189 x 219	36.5	A-Pol
SB12/130 A	12	130	91164085		513 x 223 x 219	45.5	A-Pol
SB12/185 A	12	185	20310236		518 x 274 x 238	61.5	A-Pol

* Discontinued item from the manufacturer >>> Please send us your inquiry.



Please order by phone: +49 40 611 631-0, by email: bestellung@battery-kutter.de,
by fax: +49 40 611 631-79 or visit our online shop: www.battery-kutter.de



Product	GEL batteries
Version	GEL technology – grid plates, sealed
Condition	Filled and charged
Quality	Original equipment quality
Use	High cyclic use
Shelf life	Up to 12 months
Characteristics	Low self-discharge, absolutely maintenance-free
Application	Hazard and smoke detection systems, emergency lighting, electric wheel-chairs, mobile lifting platforms, cleaning equipment, solar applications, construction site lighting, emergency power and UPS systems, etc.

Powerfit S300

Product	Volt (V)	Ah (C20)	Art. no.	Eurobat (years)	L x W x H (mm)	Weight (kg)	Connector	VdS no.
S306/4 S	6	4.5	91236275	5	70 x 47 x 106	0.8	S-4.8	
S306/12 S	6	12	91236295	5	151 x 51 x 100	2.0	S-4.8	G112097
S312/2.3 S	12	2.1	2030976	5	178 x 35 x 66	1.0	S-4.8	G112094
S312/3.2 S	12	3.4	2031226	5	134 x 67 x 67	1.4	S-4.8	G112095
S312/4 S	12	4.5	91344035	5	90 x 70 x 107	1.5	S-4.8	
S312/7 S	12	7.2	2030732	5	152 x 66 x 100	2.5	S-4.8	G112096
S312/7 SR	12	7.2	93126935	5	152 x 66 x 100	2.5	SR-6.3	G112096
S312/12 SR	12	12	93126945	5	152 x 98 x 102	3.8	SR-6.3	G112098
S312/18 F5	12	18	2032107	5	182 x 77 x 168	5.8	F-M5	G112099
S312/26 F5	12	26	2032004	5	167 x 175 x 125	8.0	F-M5	G112100
S312/40 F6	12	38	2032526	5	197 x 165 x 170	13.2	F-M6	G112101



* Discontinued item from the manufacturer >>> Please send us your inquiry.

Please order by phone: +49 40 611 631-0, by email: bestellung@battery-kutter.de,
by fax: +49 40 611 631-79 or visit our online shop: www.battery-kutter.de



Product	GEL batteries
Version	GEL technology – grid plates, sealed
Condition	Filled and charged
Quality	Original equipment quality
Use	High cyclic use
Shelf life	Up to 12 months
Characteristics	Low self-discharge, absolutely maintenance-free
Application	Hazard and smoke detection systems, emergency lighting, electric wheel-chairs, mobile lifting platforms, cleaning equipment, solar applications, construction site lighting, emergency power and UPS systems, etc.

Sonnenschein A400

Product	Volt (V)	Ah (C10)	Art. no.	Eurobat (years)	L x W x H (mm)	Weight (kg)	Connector
A406/165 A	6	165	93132995	12+	246 x 192 x 275	28.0	A-Pol
A406/165 F10	6	165	20310240	12+	246 x 192 x 282	28.5	F-M10
A412/5.5 SR*	12	5.5	2030827	12+	152 x 65.5 x 98.4	2.5	SR-6.3
A412/8.5 SR*	12	8.5	2031220	12+	152 x 98 x 98.4	3.6	SR-6.3
A412/12 SR*	12	12	2031546	12+	181 x 76 x 157	5.6	SR-6.3
A412/20 G5	12	20	2031645	12+	167 x 176 x 126	9.0	G-M5
A412/32 F10	12	32	20310241	15	210 x 175 x 181	14.1	F-M10
A412/32 G6	12	32	2032641	15	210 x 175 x 175	13.6	G-M6
A412/50 A	12	50	2031752	15	278 x 175 x 190	18.5	A-Pol
A412/50 F10	12	50	93129675	15	278 x 175 x 196	19.0	F-M10
A412/50 G6	12	50	91404855	15	278 x 175 x 190	18.5	G-M6
A412/65 F10	12	65	20310242	15	353 x 175 x 196	23.5	F-M10
A412/65 G6	12	65	91292685	15	353 x 175 x 190	23.0	G-M6
A412/90 A	12	90	93106815	15	286 x 269 x 230	33.0	A-Pol
A412/90 F10	12	90	20310243	15	286 x 269 x 234	33.5	F-M10
A412/100 A	12	100	91274105	15	513 x 189 x 219	36.5	A-Pol
A412/100 F10	12	100	20310244	15	513 x 189 x 223	37.0	F-M10
A412/120 A	12	120	2032041	15	513 x 223 x 219	45.0	A-Pol
A412/120 F10	12	120	20310245	15	513 x 223 x 223	45.5	F-M10
A412/180 A	12	180	2031751	15	518 x 274 x 238	63.0	A-Pol
A412/180 F10	12	180	93127385	15	518 x 274 x 244	63.5	F-M10



* Discontinued item from the manufacturer >>> Please send us your inquiry.

Please order by phone: +49 40 611 631-0, by email: bestellung@battery-kutter.de,
by fax: +49 40 611 631-79 or visit our online shop: www.battery-kutter.de



Product	GEL batteries
Version	GEL technology – grid plates, sealed
Condition	Filled and charged
Quality	Original equipment quality
Use	High cyclic use
Shelf life	Up to 12 months
Characteristics	Low self-discharge, absolutely maintenance-free
Application	Hazard and smoke detection systems, emergency lighting, electric wheel-chairs, mobile lifting platforms, cleaning equipment, solar applications, construction site lighting, emergency power and UPS systems, etc.

Sonnenschein A600 Block

Product	Volt (V)	Ah (C20)	Art. no.	Eurobat (years)	L x W x H (mm)	Weight (kg)	Connector
A606/200	6	200	2030559	15	272 x 206 x 347	45.7	F-M8
A606/300	6	300	2030400	15	380 x 206 x 347	65.4	F-M8
A612/100	12	100	93107005	15	272 x 206 x 347	46.2	F-M8
A612/150	12	150	91371315	15	380 x 206 x 347	66.9	F-M8



* Discontinued item from the manufacturer >>> Please send us your inquiry.

Please order by phone: +49 40 611 631-0, by email: bestellung@battery-kutter.de,
by fax: +49 40 611 631-79 or visit our online shop: www.battery-kutter.de



Product	GEL batteries
Version	GEL technology – grid plates, sealed
Condition	Filled and charged
Quality	Original equipment quality
Use	High cyclic use
Shelf life	Up to 12 months
Characteristics	Low self-discharge, absolutely maintenance-free
Application	Hazard and smoke detection systems, emergency lighting, electric wheel-chairs, mobile lifting platforms, cleaning equipment, solar applications, construction site lighting, emergency power and UPS systems, etc.

Marathon L/ XL

Product	Volt (V)	Ah (C10)	Art. no.	Eurobat (years)	L x W x H (mm)	Weight (kg)	Connector
L6V110	6	112	2033090	12+	272 x 166 x 190	21.3	M-M8
L12V24	12	23.5	2031255	12+	168 x 127 x 174	9.5	M-M6
L12V32	12	31.5	2031713	12+	198 x 168 x 175	13.5	M-M6
XL6V180	6	179	20310276	12+	309 x 172 x 241	29.0	F-M6
XL12V50	12	50.4	2033505	12+	220 x 172 x 235	19.1	F-M6
XL12V70	12	66.6	2031983	12+	262 x 172 x 239	23.6	F-M6
XL12V85	12	85.7	2033888	12+	309 x 172 x 239	28.3	F-M6

Marathon M FT

Product	Volt (V)	Ah (C10)	Art. no.	Eurobat (years)	L x W x H (mm)	Weight (kg)	Connector
M6V200FT	6	200	20310286	15	361 x 132 x 250	34.0	F-M6
M12V35FT	12	35	2034117	15	280 x 107 x 189	14.0	M-M6
M12V50FT	12	47	2033627	15	280 x 107 x 231	18.0	M-M6
M12V60FT	12	59	20310284	15	280 x 107 x 263	23.0	M-M6
M12V90FT	12	86	20310285	15	395 x 105 x 270	31.0	F-M6
M12V100FT	12	100	20311985	15	395 x 105 x 287	33.0	F-M6
M12V105FT	12	100	2033959	15	511 x 110 x 238	35.8	F-M6
M12V125FT	12	121	2034411	15	559 x 124 x 283	47.6	F-M6
M12V155FT	12	150	20310118	15	559 x 124 x 283	52.8	F-M6
M12V190FT	12	190	20311372	15	559 x 125 x 318	62.0	F-M6



* Discontinued item from the manufacturer >>> Please send us your inquiry.

Please order by phone: +49 40 611 631-0, by email: bestellung@battery-kutter.de,
by fax: +49 40 611 631-79 or visit our online shop: www.battery-kutter.de



Product	GEL batteries
Version	GEL technology – grid plates, sealed
Condition	Filled and charged
Quality	Original equipment quality
Use	High cyclic use
Shelf life	Up to 12 months
Characteristics	Low self-discharge, absolutely maintenance-free
Application	Hazard and smoke detection systems, emergency lighting, electric wheel chairs, mobile lifting platforms, cleaning equipment, solar applications, construction site lighting, emergency power and UPS systems, etc.

Sprinter P

Product	Volt (V)	Ah (C10)	Art. no.	Eurobat (years)	L x W x H (mm)	Weight (kg)	Connector	VdS no.
P6V1700	6	122	2031185	10–12	273 x 167 x 191	25.0	M-M8	
P12V600	12	24	2031318	10–12	169 x 128 x 175	9.5	M-M6	G199100
P12V875	12	41	2030542	10–12	200 x 169 x 176	14.5	M-M6	G100017
P12V1575	12	61	2030570	10–12	273 x 167 x 191	24.0	M6	G199101

Sprinter XP

Product	Volt (V)	Ah (C10)	Art. no.	Eurobat (years)	L x W x H (mm)	Weight (kg)	Connector	VdS no.
XP6V2800	6	195	20310288	10–12	309 x 172 x 241	30.5	F-M6	G111052
XP12V1800	12	56.4	2033892	10–12	220 x 172 x 235	21.0	F-M6	
XP12V2500	12	69.5	93132075	10–12	262 x 172 x 239	26.0	F-M6	G111052
XP12V3000	12	92.8	2033644	10–12	309 x 172 x 239	31.0	F-M6	
XP12V3400	12	105	20310287	10–12	351 x 172 x 239	35.5	F-M6	
XP12V4000	12	120	2037681	10–12	351 x 172 x 291	43.6	F-M6	
XP12V4400	12	140	2030190	10–12	351 x 172 x 291	46.7	F-M6	

Sprinter XP-FT

Product	Volt (V)	Ah (C10)	Art. no.	Eurobat (years)	L x W x H (mm)	Weight (kg)	Connector	VdS no.
XP12V4400FT	12	155	20310289	12+	559 x 124 x 283	54.3	F-M6	
XP12V5300FT	12	186	20311373	12+	559 x 125 x 318	62.0	F-M6	

Sprinter Pure Power

Product	Volt (V)	Ah (C10)	Art. no.	Eurobat (years)	L x W x H (mm)	Weight (kg)	Connector	VdS no.
S6V3100PP	6	195	2037851	12+	309 x 172 x 223	30.5	M6	
S12V2000PP	12	56.4	2037852	12+	220 x 172 x 219	21	M6	
S12V2800PP	12	69.5	2037853	12+	262 x 172 x 223	26	M6	
S12V3400PP	12	92.8	2037854	12+	309 x 172 x 223	31	M6	
S12V3800PP	12	105	2037855	12+	351 x 172 x 223	35.5	M6	
S12V4500PP	12	120	2037856	12+	351 x 172 x 275	43.6	M6	
S12V5200PP	12	140	2037857	12+	351 x 172 x 275	46.6	M6	



* Discontinued item from the manufacturer >>> Please send us your inquiry.

Please order by phone: +49 40 611 631-0, by email: bestellung@battery-kutter.de,
by fax: +49 40 611 631-79 or visit our online shop: www.battery-kutter.de



Product	AGM battery
Version	AGM technology – grid plates, sealed
Condition	Filled and charged
Quality	Original equipment quality
Use	High cyclic use
Shelf life	Up to 12 months
Characteristics	Low self-discharge, absolutely maintenance-free
Application	Hazard and smoke detection systems, safety lighting, electric wheelchairs, mobile lifting platforms, cleaning equipment, solar applications, construction site lighting, emergency power and UPS systems, etc.

Standard Commercial 6V

Product	Volt (V)	Ah (C20)	Art. no.	Eurobat (years)	L x W x H (mm)	Weight (kg)	Terminal	VdS no.
NP1.2-6	6	1.2	203067	3–5	97 x 25 x 54.5	0.31	4.8 mm	
NP3-6	6	3	203306	3–5	134 x 34 x 64	0.57	4.8 mm	
NP4-6	6	4	203124	3–5	70 x 47 x 105.5	0.87	4.8 mm	
NP7-6	6	7	203013	3–5	151 x 34 x 97.5	1.32	4.8 mm	
NP10-6	6	10	203054	3–5	151 x 50 x 97.5	1.93	4.8 mm	G189170
NP12-6	6	12	203035	3–5	151 x 50 x 97.5	2.05	6.3 mm	G194006

Standard Commercial 12V

Product	Volt (V)	Ah (C20)	Art. no.	Eurobat (years)	L x W x H (mm)	Weight (kg)	Terminal	VdS no.
Y0.8-12	12	0.8	203059	3–5	96 x 25 x 62	0.36	JST	
NP1.2-12	12	1.2	203049	3–5	97 x 48 x 54.5	0.58	4.8 mm	G101094
NP2.3-12	12	2.3	203071	3–5	178 x 34 x 64	0.95	4.8 mm	G101139
NP3.2-12	12	3.2	203051	3–5	134 x 67 x 64	1.20	4.8 mm	
NP4-12	12	4	203047	3–5	90 x 70 x 106	1.75	4.8 mm	
NP7-12	12	7	203050	3–5	151 x 65 x 97.5	2.20	4.8 mm	G189099
NP7-12L	12	7	203369	3–5	151 x 65 x 97.5	2.20	6.3 mm	G189099
NP12-12	12	12	203027	3–5	151 x 98 x 97.5	4.05	6.3 mm	G189170
NP17-12	12	17	203044	3–5	181 x 76 x 167	6.10	M5	G197022
NP24-12I	12	24	203034	3–5	166 x 175 x 125	9.00	M5	G182026
NP38-12I	12	38	203028	3–5	197 x 165 x 170	14.20	M5	G182024
NP65-12I	12	65	203032	3–5	350 x 166 x 174	23.00	M6	G183008



Please order by phone: +49 40 611 631-0, by email: sales@battery-kutter.de,
by fax: +49 40 611 631-79 or visit our online shop: www.battery-kutter.de



Product AGM battery
Version AGM technology – grid plates, sealed
Condition Filled and charged
Quality Original equipment quality
Use High cyclic use
Shelf life Up to 12 months
Characteristics Low self-discharge, absolutely maintenance-free
Application Hazard and smoke detection systems, safety lighting, electric wheelchairs, mobile lifting platforms, cleaning equipment, solar applications, construction site lighting, emergency power and UPS systems, etc.

High Power Series

Product	Volt (V)	Watt (10 min)	Art. no.	Eurobat (years)	L x W x H (mm)	Weight (kg)	Terminal
NP5-12L	12	190	2037892	3–5	90 x 70 x 106	1.85	6.3 mm
NPW45-12	12	273	2033727	3–5	151 x 65 x 97.5	2.70	6.3 mm

High Cycle Series

Product	Volt (V)	Ah (C20)	Art. no.	Eurobat (years)	L x W x H (mm)	Weight (kg)	Terminal
NPC24-12I	12	24	203068	3–5	166 x 175 x 125	9.00	M5
NPC38-12I	12	38	203069	3–5	197 x 165 x 170	14.00	M5
NPC100-12	12	100	20310176	3–5	350 x 168 x 225	38.80	M8

High Performance

Product	Volt (V)	Ah (C20)	Art. no.	Eurobat (years)	L x W x H (mm)	Weight (kg)	Terminal
NPL130-6IFR	6	130	2030048	10–12	350 x 166 x 174	23.00	M6
NPL200-6	6	200	2031033	10–12	398 x 176 x 250	39.00	10 mm bolt
NPL24-12I	12	24	20312241	10–12	166 x 175 x 125	9.00	M5
NPL38-12I	12	38	20312381	10–12	197 x 165 x 170	14.00	M5
NPL65-12I	12	65	2030848	10–12	350 x 166 x 174	23.00	M6
NPL78-12IFR	12	78	203074	10–12	380 x 166 x 174	27.50	M8
NPL100-12FR	12	100	203057	10–12	407 x 172 x 240	39.00	10 mm bolt



Please order by phone: +49 40 611 631-0, by email: sales@battery-kutter.de, by fax: +49 40 611 631-79 or visit our online shop: www.battery-kutter.de

Consumer Batteries

Duracell Procell

	Product	Art. no.	PU
	Duracell Procell Intense AAA MN2400/LR03	1020277	10s Tray
	Duracell Procell Intense AA PX1500/LR06	1020275	10s Tray
	Duracell Procell Intense C MN1400/LR14 Baby	1020276	10s Tray
	Duracell Procell Intense D MN1300/LR20	1020278	10s Tray
	Duracell Procell Intense 9V MN1604/6LR61	1020279	10s Tray

Duracell Plus + 100% Extra

	Product	Art. no.	PU
	Duracell Plus AAA MN2400/LR3	1020250	4s Blister
	Duracell Plus AA MN1500/LR6	1020245	4s Blister
	Duracell Plus AA MN1500/LR6	1020246	8s Blister
	Duracell Plus AA MN1500/LR6	1020266	10s Blister
	Duracell Plus AA MN1500/LR6	1020248	16s Blister
	Duracell Plus C MN1400/LR14	1020255	2s Blister
	Duracell Plus D MN1300/LR20	1020257	2s Blister
	Duracell Plus 9 V MN1604/6LR61	1020259	1s Blister
	Duracell Plus 9 V MN1604/6LR61	1020260	2s Blister
	Duracell Plus 4,5 V MN1203/3LR12	1020261	1s Blister

Duracell Security

	Product	Art. no.	PU
	Duracell Security MN11 6 V	1020114	1s Blister
	Duracell Security MN21 3LR50 12 V	1020119	2s Blister
	Duracell Security MN27 12 V	1020135	1s Blister
	Duracell Security MN9100 N Lady LR1 1,5 V	1020046	2s Blister

Duracell Hearing Aid

	Product	Art. no.	PU
	Duracell EasyTab 10	91351195	6s Blister
	Duracell EasyTab 13	91328725	6s Blister
	Duracell EasyTab 312	91351205	6s Blister
	Duracell EasyTab 675	91351215	6s Blister

Duracell Lithium

	Product	Art. no.	PU
	Duracell Lithium CR123 Bulk	1040074	Piece
	Duracell Lithium CR2 2er Blister	1040080	2s Blister



Please order by phone: +49 40 611 631-0, by email: bestellung@battery-kutter.de,
by fax: +49 40 611 631-79 or visit our online shop: www.battery-kutter.de

Varta Industrial PRO

	Product	Art. no.	PU
	Varta Industrial PRO AAA	1020156	4s Foil
	Varta Industrial PRO AAA	1020188	10s Tray
	Varta Industrial PRO AA	1020040	4s Foil
	Varta Industrial PRO C	1020179	Piece
	Varta Industrial PRO D	1020180	Piece

Varta Longlife Power

	Product	Art. no.	PU
	Varta Longlife Power AAA	102020	4s Blister
	Varta Longlife Power AAA	1020158	8s Blister
	Varta Longlife Power AAA	1020159	10s Blister
	Varta Longlife Power AAA	1020028	10s Tray
	Varta Longlife Power AA	1020029	4s Foil
	Varta Longlife Power AA	1020054	4s Blister
	Varta Longlife Power AA	1020160	8s Blister
	Varta Longlife Power AA	1020161	10s Blister
	Varta Longlife Power C	1020056	Piece
	Varta Longlife Power D	1020057	Piece
	Varta Longlife Power 9V	102024	1s Blister
	Varta Longlife Power 9V	1020031	Piece

Varta Longlife Max Power

	Product	Art. no.	PU
	Varta Longlife Max Power AAA	1020032	4s Blister
	Varta Longlife Max Power AA	1020050	4s Blister
	Varta Longlife Max Power C	1020172	2s Blister
	Varta Longlife Max Power D	1020173	2s Blister
	Varta Longlife Max Power 9 V	1020174	1s Blister

Varta Recharge Accu Power

	Product	Art. no.	PU
	Varta Recharge Accu Power AAA Mikro 1,2 V 800 mAh	2010195	2s Blister
	Varta Recharge Accu Power AAA Mikro 1,2 V 800 mAh	2010061	4s Blister
	Varta Recharge Accu Power AAA Mikro 1,2 V 1000 mAh	2010226	2s Blister
	Varta Recharge Accu Power AAA Mikro 1,2 V 1000 mAh	2010143	4s Blister
	Varta Recharge Accu Power AA Mignon 1,2 V 2100 mAh	2010074	2s Blister
	Varta Recharge Accu Power AA Mignon 1,2 V 2100 mAh	2010191	4s Blister
	Varta Recharge Accu Power AA Mignon 1,2 V 2600 mAh	2010229	2s Blister
	Varta Recharge Accu Power AA Mignon 1,2 V 2600 mAh	22010230	4s Blister
	Varta Recharge Accu Power C Baby 1,2 V 3000 mAh	1030027	2s Blister
	Varta Recharge Accu Power D Mono 1,2 V 3000 mAh	2010161	2s Blister
	Varta Recharge Accu Power 9 V Block 8,4 V 200 mAh	2010190	1s Blister

Varta Charger

	Product	Art. no.	PU
	Varta 57070 LCD Charger NiMH suitable for battery sizes AAA, AA incl. 4x Varta 56756 AA Mignon 2400mAh rechargeable batteries + 12V car adapter and USB cable	70210657	Piece
	Varta 57648 Universal Charger NiMH suitable for battery sizes AAA, AA, C, D, 9 V Block	70210649	Piece



Please order by phone: +49 40 611 631-0, by email: bestellung@battery-kutter.de,
by fax: +49 40 611 631-79 or visit our online shop: www.battery-kutter.de

Panasonic Powerline

	Product	Art. no.	PU
	Panasonic Powerline LR03AD AAA Mikro 1,5 V	200240s	2s Shrink
	Panasonic Powerline LR6AD AA Mignon 1,5 V	200243s	2s Shrink
	Panasonic Powerline LR14AD C Baby 1,5 V Bulk	200241	Piece
	Panasonic Powerline LR20AD D Mono 1,5 V Bulk	200242	Piece
	Panasonic Powerline 6LR61AD 9 V-Block Bulk	1020106	Piece

Panasonic Lithium

	Product	Art. no.	PU
	Panasonic Lithium Power CR123 3 V	100068	1s Blister
	Panasonic Lithium Power CR2 3 V	100075	1s Blister
	Panasonic Lithium Power CRP2 6 V	100076	1s Blister
	Panasonic Lithium Power 2CR5 6 V	100065	1s Blister

Panasonic Lithium button-cell

	Product	Art. no.	PU
	Panasonic Lithium button-cell CR1025 3 V 30 mAh	200123	Piece
	Panasonic Lithium button-cell CR1216 3 V 25 mAh	1040087	Piece
	Panasonic Lithium button-cell CR1220 3 V 35 mAh	1040088	Piece
	Panasonic Lithium button-cell CR1612 3 V 40 mAh	1040089	5s Blister
	Panasonic Lithium button-cell CR1616 3 V 55 mAh	1040090	Piece
	Panasonic Lithium button-cell CR1620 3 V 75 mAh	1040091	Piece
	Panasonic Lithium button-cell CR1632 3 V 140 mAh	1040092	Piece
	Panasonic Lithium button-cell CR2012 3 V 55 mAh	1040093	Piece
	Panasonic Lithium button-cell CR2016 3 V 90 mAh	1040094	Piece
	Panasonic Lithium button-cell CR2025 3 V 165 mAh	1040095	Piece
	Panasonic Lithium button-cell CR2032 3 V 220 mAh	1040085	Piece
	Panasonic Lithium button-cell CR2330 3 V 265 mAh	1040096	5s Blister
	Panasonic Lithium button-cell CR2354 3 V 560 mAh	1040097	Piece
	Panasonic Lithium button-cell CR2430 3 V 280 mAh	1040107	Piece
	Panasonic Lithium button-cell CR2450 3 V 620 mAh	1040099	Piece
	Panasonic Lithium button-cell CR2477 3 V 100 mAh	1040100	Piece
	Panasonic Lithium button-cell CR3032 3 V 500 mAh	1040101	Piece

Tadiran

	Product	Art. no.	PU
	Tadiran SL-350/S 1/2AA Standard	202008	Piece
	Tadiran SL-360/S AA Standard	91260485	Piece
	Tadiran SL-361/S	202023	Piece
	Tadiran SL-750/S	2020206	Piece
	Tadiran SL-760/S	202029	Piece
	Tadiran SL-761/S	202011	Piece



Please order by phone: +49 40 611 631-0, by email: bestellung@battery-kutter.de,
by fax: +49 40 611 631-79 or visit our online shop: www.battery-kutter.de

Consumer Batteries

Ultralife Lithium

	Product	Art. no.	PU
	Ultralife U9VL-J-P Lithium 9 V Block	100077	Piece

Renata

	Product	Art. no.	PU
	Renata CR2477 N	200144	1s Blister

Saft Lithium Batteries

	Product	Art. no.	PU
	Saft LS 14250 1/2AA Lithium 3,6 V	2020015	Piece
	Saft LS 14500 AA Lithium 3,6 V	202013	Piece
	Saft LS 17500 A Lithium 3,6 V	2020221	Piece
	Saft LS 26500 C Lithium 3,6 V	202006	Piece
	Saft LS 33600 D Lithium 3,6 V	2020013	Piece
	Saft LSH14 C Lithium 3,6 V	2020017	Piece
	Saft LSH20 D Lithium 3,6 V	2020085	Piece



Please order by phone: +49 40 611 631-0, by email: bestellung@battery-kutter.de,
by fax: +49 40 611 631-79 or visit our online shop: www.battery-kutter.de

Our team

Get to know our power-team! #teamkutter

We're here for you – by phone, email and of course in person!

Managing Directors



Hendrik Kutter

Managing Director

Contact: +49 40 401 161-0

hkutter@battery-kutter.de



Kai Kutter

Managing Director

Contact: +49 40 401 161-0

kkutter@battery-kutter.de

Head of Sales



Bastian Valentin

Head of Sales / Proxy

Contact: +49 40 401 161-019

bvalentin@battery-kutter.de

HR & Administration



Saskia Schultheis

Team Lead HR & Administration

Contact: +49 40 401 161-101

sschultheis@battery-kutter.de

Sales North / Sales East



René Freigang

Key Account Manager East

Contact: +49 40 401 161-071

rfreigang@battery-kutter.de



Benjamin Backof

Key Account Manager North

Contact: +49 40 401 161-021

bbackof@battery-kutter.de



Kim Schulze

Sales Manager

Contact: +49 40 401 161-024

kschulze@battery-kutter.de



Madolyn Sichtung

Sales Manager

Contact: +49 40 401 161-023

msichtung@battery-kutter.de



Jarred Neubert

Sales Manager

Contact: +49 40 401 161-042

jneubert@battery-kutter.de

Sales South / Sales West



Sascha Pella

Key Account Manager South

Contact: +49 40 401 161-072

spella@battery-kutter.de



Matchello Koch

Key Account Manager West

Contact: +49 40 401 161-025

mkoch@battery-kutter.de



Jelena Böhme

Team Lead Sales

Contact: +49 40 401 161-028

jboehme@battery-kutter.de



Patrick Ahlf

Senior Sales Manager

Contact: +49 40 401 161-027

pahlf@battery-kutter.de



Kristin Kalfhaus

Sales Manager

Contact: +49 40 401 161-031

kkalfhaus@battery-kutter.de



Lisa Meyer

Sales Manager

Contact: +49 40 401 161-032

lmeyer@battery-kutter.de



Patrick Prior

Sales Manager

Contact: +49 40 401 161-051

pprior@battery-kutter.de

Our team

Sales National



Christian Bartolles

Business Development Manager
– Pure lead energy systems
Contact: +49 40 401 161-073
cbartolles@battery-kutter.de



Michael Kewitz

Key Account Manager
Contact: +49 40 401 161-075
mkewitz@battery-kutter.de



Frank Schröder

Senior Project Sales Manager
Contact: +49 40 401 161-033
fschroeder@battery-kutter.de



Martin Sader

Senior After Sales Manager
Contact: +49 40 401 161-022
msader@battery-kutter.de



Melissa Marienfeld

Inside Sales Manager
Contact: +49 40 401 161-029
mmarienfeld@battery-kutter.de

Project Management

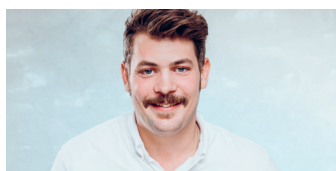

Fabian Beuster

Team Lead Project Management
Contact: +49 40 401 161-201
fbeuster@battery-kutter.de

Marketing



Julia von Kap-herr

Head of Marketing
Contact: +49 40 401 161-0
jvkapherr@battery-kutter.de

Accounting



Sandra Ehni

Team Lead Finance
Contact: +49 40 401 161-181
sehni@battery-kutter.de

Quality Management



Franc Meyer

Team Lead QM
Contact: +49 40 401 161-012
fmeyer@battery-kutter.de

Technology



Brian Marsen

Team Lead Technical Department
Contact: +49 40 401 161-241
bmarsen@battery-kutter.de

IT



Danny Blank

Team Lead IT + DevOps Engineer
Contact: +49 40 401 161-0
dblank@battery-kutter.de

Logistics



Karl Preuß

Team Lead Logistics
Contact: +49 40 401 161-140
lager@battery-kutter.de

Battery-Kutter

Battery-Kutter GmbH & Co. KG
Robert-Koch-Straße 19a · D-22851 Norderstedt
Phone: +49 40 401 161-0 · Fax: +49 40 401 161-79
Email: info@battery-kutter.de

www.battery-kutter.com



Managementsysteme
Produkte



ID: 336B05EE
www.vds.de/id