

Starter Batteries

START POWER NG



intAct Start-Power NG

Maintenance-free calcium battery (Ca/Ca) | wet charged



intAct
BATTERY - POWER

ONE THAT FITS ALL

Fully meets the requirements of all vehicles. Both for older vehicles as well as for newer models with charging voltage up to 14.8 volts. For passenger cars, also from Asia and super-shakeproof for trucks. Our recommendation for a solid battery when cost is a major consideration.

- » Approved for charging voltage up to 14.8 volts.
- » Very powerful, maintenance-free and extremely reliable.
- » Double lid for increased leak protection and vapour condensation (gaseous electrolyte condenses in the labyrinth lid and remains in the circuit).
- » 2 versions: For cars (including Asia models) and Super-Heavy-Duty (SHD) for trucks.
- » SHD version with glass mat separators vibration-resistant V3. For complexly equipped, heavy commercial vehicles even under the most difficult conditions.

START POWER NG



Artnum. 53520GUG

Japan-Code keine

Volt 12V

Capacity 35 AH (c20)

CCR - 18°C (EN) 300 A (EN)

Electrolyte diluted sulphuric acid

Electrolyte density 1,28 +/- 0,01 Kg/l (25° C)

Size (LxWxH) 187 x 127 x 227 mm

Weight 9,8 kg

Pos. of Terminal 0

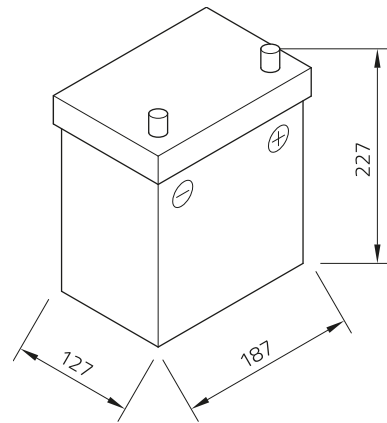
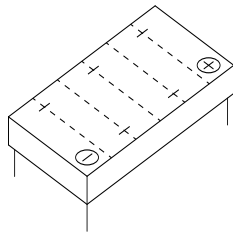

Technology Maintenance-free calcium battery (Ca/Ca) | wet charged

Terminal 3

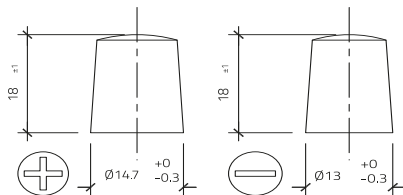

Base plate -

As of 23.11.2022